

Video Recorder User Manual

2016-6

1 Important Safeguards and Warnings

Electrical safety

All installation and operation should conform to your local electrical safety codes. We assume no liability or responsibility for any fires or electrical shock caused by improper handling or installation.

Transportation security

Heavy stress, violent vibration or water splash should be avoided during transportation, storage and installation.

Installation

- Keep upright. Handle with care.
- Do not apply power to the NVR before completing installation.
- Do not place objects on top of the NVR

Qualified engineers needed

- All examination and repair work should be done by qualified service engineers.
- We are not liable for any problems caused by unauthorised modifications or attempted repair.

Environment

- The NVR should be installed in a cool, dry place away from direct sunlight and inflammable or explosive substances, etc.
- This product should be transported, stored and operated in the specified environments.

Accessories

- Be sure to use all the accessories available in the package.
- Before installation, please open the package and check all the components are included.
- Contact your local retailer if something is broken or missing in your package.

Lithium battery

- Improper battery use may result in fire, explosion, or personal injury.
- When replacing the battery, please make sure you use the same model.

2 Declaration

Please prevail in kind. The manual is for reference only.

This manual may contain inaccurate data or printing error.

The products described in this manual may be updated at any time.

Screenshots of the manual is not in a machine and only for display.

If in doubt, obtaining a copy of the latest procedure or the additional document, please contact with the company's after-sales department.

TABLE OF CONTENTS

1 Important Safeguards and Warnings	2
2 Declaration	3
3 Product Introduction.....	1
3.1 Product Overview.....	1
3.2 Feature.....	1
4 Read First	2
4.1 Front Panel	2
4.2 Remote Control	3
4.3 The Mouse.....	5
4.4 The Input Method.....	6
4.5 Icon.....	6
4.5.1 The Screen Icons.....	6
4.5.2 Operation Icons	7
5 Installation	7
5.1 Unpacking Inspection.....	7
5.2 HDD Installation	7
5.3 Installation of the burner	8
5.4 Alarm/PTZ/Control Keyboard Interface	8
5.5 POE Connection.....	10
6 Basic Operations Guide	10
6.1 Power On and Off	10
6.1.1 Power On.....	10
6.1.2 Power Off (Shutdown).....	11
6.1.3 Restart	11
6.1.4 Power recovery	11
6.2 Start-up wizard	11
6.3 Add Device.....	13
6.3.1 Channel Mode Switch	13
6.3.2 QUICK ADD IP CAMERA	14
6.3.3 Adding Menu.....	15
6.3.4 Automatically added	16
6.3.5 Searching Added.....	17
6.3.6 Modify channel configuration	17
6.3.7 Configure Front Device.....	17
6.3.8 Delete Front Device	20
6.3.9 Others.....	20
6.4 The event of configuration	20
6.4.1 Detect configuration.....	20
6.4.2 Intelligent analysis	22
6.4.3 Alarm input.....	24
6.4.4 Equipment Abnormal	26
6.5 Log in/Log out.....	26
6.6 Preview.....	27

6.6.1	Live Preview	27
6.6.2	Channel Toolbar	28
6.6.3	Right Click Menu	29
6.6.4	Task Bar	31
6.7	Search	33
6.7.1	Search	33
6.7.2	Event Search	36
6.7.3	Tag Search	37
6.7.4	Smart Serach	37
6.7.5	External Search	39
6.7.6	Face search	40
6.8	Record Backup	40
7	local Configuration	41
7.1	The Introduction of the Main Menu	41
7.2	INFO	42
7.2.1	[System]:	43
7.2.2	Event	44
7.2.3	Net Channel	44
7.2.4	LOG	46
7.3	CONFIG	46
7.3.1	Channel Setting	46
7.3.2	Storage	48
7.3.3	PTZ setting	50
7.3.4	Alarm	51
7.3.5	Channel Mode Switch	51
7.4	Backup	51
7.5	Application	51
7.5.1	DDNS	52
7.5.2	Email	53
7.5.3	P2P	53
7.5.4	Cloud storage	54
7.5.5	PUSH	54
7.6	System setting	54
7.6.1	Basic setting	54
7.6.2	Video output	55
7.6.3	Storage management	56
7.6.4	ABNORMITY	58
7.6.5	System Status	58
7.6.6	Maintain	59
7.6.7	Account	61
7.6.8	Network	62
7.6.9	RS232	65
8	WEB Access	65
8.1	WEB Operation	65

8.1.1	Network Connection	65
8.1.2	The control installation and the user login logout	66
8.1.3	The Interface Of Web Operations.....	67
8.1.4	The Real-time Monitoring	68
8.1.5	PTZ Control	69
8.1.6	Configuration.....	70
8.1.7	Search Record.....	71
8.1.8	Alarm Configuration	72
8.1.9	About.....	72
9	Appendix	73
9.1	Alarm linkage setting	73
9.1.1	Alarm Out	73
9.1.2	Linkage Record	73
9.1.3	Snapshot.....	74
9.1.4	PTZ Linkage.....	74
9.1.5	Tour	74
9.1.6	Show Message.....	74
9.1.7	Buzzer	75
9.1.8	Send Email.....	75
9.1.9	Server push.....	76
9.1.10	Send NetDisk.....	76
9.2	Port Mapping.....	77
9.2.1	UPNP Function	77
9.2.2	Port mapping Manually	77
9.3	Voice Intercom	78
9.3.1	Summarize.....	78
9.3.2	Configuration.....	78
9.4	HDD S.M.A.R.T	78
9.5	Hard disk problem.....	80
9.6	HDD Capacity Calculation.....	81
9.7	Terms.....	82
9.8	FAQ.....	82

3 Product Introduction

3.1 Product Overview

This series DVR/NVR is a high performance network video recorder, combined with H.264 video compression, high-capacity hard disk storage, TCP / IP transmission, embedded Linux operating system and a variety of other advanced technologies in the electronic information industry, all those ensure that a high-quality, low bit rate video storage characteristics, and good system stability.

This product complies with GB 20815-2006 standard video security surveillance digital video recording promulgated by the State. At the same time, the product supports the ONVIF protocol” base on’ ONVIF™ Core Specification’ Version 2.2” and is compatible with the network cameras which supports ONVIF protocol.

Some of the products can enable the switching between the NVR mode and Hybrid mode “Hybrid mode supports both analog cameras and network cameras, NVR mode only supports network cameras”. This series product support local preview, multiple-window display, recorded file local storage, remote control and mouse shortcut menu operation, and remote management and control function. recording, playback, monitoring, synchronization of audio and video. Besides, the products support advanced control technology and strong network data transmission capacity.

3.2 Feature

Real-time monitoring

Have a composite video signal interface and support TV, VGA or HDMI output simultaneously.

Compression function

Use H.264 video compression standard and G.711 audio compression standard and have high definition, low code rate of the video coding and the storage.

Recording function

Support timing, linkage alarm, motion detection, SATA hard and local hard disk , DVR data backup and network backup.

Video playback function

Achieve searching videos by a variety of conditions, playback in local and network. Support multiple videos playback, fast playing, slow playing and frame-by-frame playback. Video playback can display the exact time of the incident. Provide time-line retrieving page for quick searching.

Camera control and alarm

Be controlled by the remote camera and equip many alarm input interfaces. Be connected to various types of alarm devices. Dynamic detection, video loss, video block, multiple alarm output and scene lighting control can be realized.

Communication Interface

Equip USB 2.0 high-speed interface or ESATA interface and allow many backup devices. Equip standard Ethernet interface. Plug and play in a variety of network conditions,

Network functions

Support TCP / IP, UDP, RTP / RTSP, DHCP, PPPOE, DDNS, NTP P2P etc. Support real-time network monitoring, video playback, control and management functions; built-in WEB Server, you can directly access through a

browser.

Operation Mode

Support various shortcut menu operation modes, on the front panel, remote control, mouse, etc; Support simple and intuitive GUI.

Intelligent analysis

Support One or Two channel Intelligent Video Analysis, such as Face detection and perimeter analysis, Intelligent linkage pictures storage, videos, external alarm

Intelligent Search

Data can be retrieved through the intelligent analysis of data. Such as face detection data to achieve through face image search, or by perimeter realization event video analysis data retrieval.

Channel Switch

The simulating device compatible with IP channel by the TVR channel switch.

4 Read First

4.1 Front Panel





No	Name	Icon	Function
1	Power	Power	Power button, press this button to boot up or shut down DVR/NVR.
2	Shift	Shift	1. In input Box, switch input methods; 2. Switch TAB;
3	Number Key	1~9	1. Number Input(in number mode); 2. English character Input(in English mode); 3. Switch channel (in 1-ch mode).
4	Input number more than 10	+10	Enter a digital larger than 10, press two-digit number: 1. Press the tens digit; 2. Press digital switch button; 3. Press ones digit.
5	Up/Down	↑↓	1. Assistant function such as PTZ menu; 2. In monitor mode, switch between multiple-window and one-window; 3. Activate the digital input box increase or decrease the number; 4. Active pull-down menu to switch the drop-down box options; 5. Activate checkbox to change status; 6. Activate the text input box and step down carry and abdication; 7. Activate the control box to move the slider; 8. Activate display window to select the previous channel, next channel.
6	Left/Right	←→	1. Shift current activated control, and then move left and right; 2. In monitor mode, switch channel.
7	ESC	ESC	Go to previous menu, or cancel current operation.
8	Enter	ENTER	1. Confirm current operation; 2. Go to OK button; 3. Go to menu.



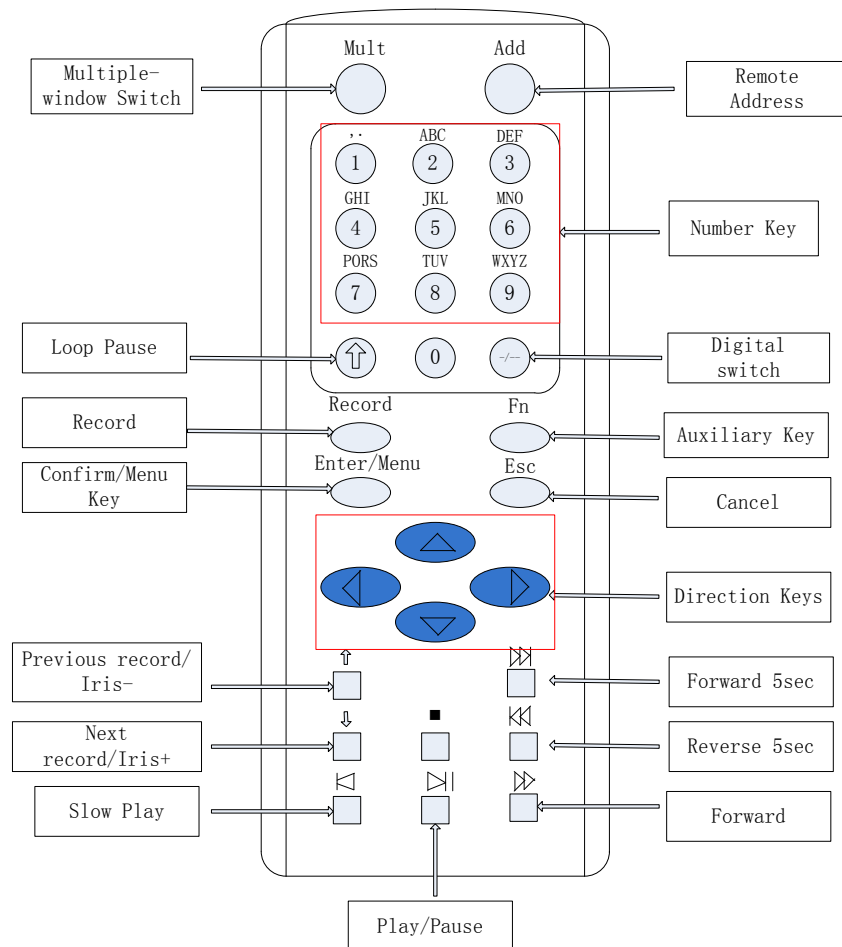

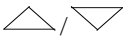
9	Function Key		Shortcut function with FN key.
10	Auxiliary	Fn	<ol style="list-style-type: none"> 1. One-window monitor mode, click this button to display assistant function: PTZ control and image color; 2. Detection areas setting(like in motion detection setup), working with Fn and direction keys to realize setup; 3. In text mode, click it to delete the character before the caret(if there is no shift on the front panel, it can switch input methods), press this button for 1.5sec to clear all of the characters; 4. In playback mode, switch the full screen; 5. Realize other special functions.
11	Play/Pause	▶	<ol style="list-style-type: none"> 1. Go to SEARCH interface; 2. In PTZ channel: ZOOM+; 3. In normal playback click this button to pause playback; 4. In pause mode, click this button to resume playback.
12	Shuttle(outer ring)		In real-time monitor mode it works as left/right direction key.
13	Jog(inner dial)		In real-time monitor mode it works as up/down direction key.

4.2 Remote Control

The remote control interface is shown as below:



Name	Icon	Function
Multiple-Window Switch	Mult	Switch between multiple-window and one-window.
Remote Address	Add	Click it to input device number, so that you can control it.
Number Key	0~9	1.input numbers (in number mode) 2.input English character (in English mode) 3.switch channel (one-window mode)
Loop Pause		Pause the loop state.
Digital Switch	-/--	Enter a digital larger than 10, press two-digit number: 1. Press the tens digit; 2. Press digital switch button; 3. Press ones digit.
Record	Record	1. Start or stop record manually. 2. In PTZ interface, click this button system can go to the Preset interface.
Auxiliary Key	Fn	1. One-window monitor mode, click this button to display assistant function: PTZ control and image color; 2. Detection areas setting(like in motion detection setup), working with Fn and direction keys to realize setup; 3. In text mode, click it to delete the character before the caret(if there is no shift on the front panel, it can switch input methods), press this button for 1.5sec to clear all of the characters; 4. In playback mode, switch the full screen; 5. Realize other special functions.
Confirm/Menu Key	Menu/Menu	1. Confirm current operation; 2. Go to OK button; 3. Go to menu.
ESC	ESC	Go to previous menu, or cancel current operation.
Direction Key		1.Assistant function such as PTZ menu; 2.In monitor mode, switch between multiple-window and one-window; 3. Activate the digital input box increase or decrease the number; 4.Active pull-down menu to switch the drop-down box options; 5. Activate checkbox to change status; 6. Activate the text input box and step down carry and abdication; 7. Activate the control box to move the slider; 8. Activate display window to select the previous channel, next channel.
		1. Shift current activated control, and then move left and right; 2. In monitor mode, switch channel; 3.Assistant function such as PTZ menu.
Previous record/Iris-		1.In playback mode, playback the previous video; 2.In PTZ mode, Iris-.
Next record/Iris+		1.In playback mode, playback the next video; 2.In PTZ mode, Iris+.
Forward 5sec		In playback mode, forward 5sec.

Reverse 5sec		In playback mode, reverse 5sec.
Slow Play		Multiple slow play speeds or normal playback.
Forward		Various forward speeds and normal speed playback.
Stop		In normal playback click this button to stop playback.
Play/Pause		<ol style="list-style-type: none"> 1. Go to SEARCH interface; 2. In PTZ channel: ZOOM+; 3. In normal playback click this button to pause playback; 4. In pause mode, click this button to resume playback.

The procedures of controlling multiple DVR by remote control:

The DVR ID default is 8. It's no need to reset it when control one single DVR by the remote control. If you need to control multiple DVR, do as below:

First activate the remote control: choose controlled DVR, starts successfully, aim the remote control to control the hard disk video recorder, press the "Add" button, input device ID) between (1-999), then press ENTER to determine can control the corresponding number of hard disk video recorder.

4.3 The Mouse

In addition to front panel keys and remote control menu, the user can use a to control. Insert the mouse interface into the USB interface.

Left Click

Left click to enter the right menu or the main interface.

Left click to access the menu option.

Perform the operations instructions of the control.

Change the state of the checkbox or dynamic detection blocks.

Pop up a drop-down list when left click.

In the state of PTZ 3D control, left drag the area to achieve regional enlarging or reducing. See details zoom effect

4.1.2 PTZ control section introduction.

Double Click

Double click to play video.

Double click to make the screen full or exit.

Right Click

Right click to pop up the right menu in the real-time monitoring screen.

Exit the current interface without saving.

Turning Wheel

Turn the mouse wheel to change the value in the digital box.

Switch the option of the combination box.

Scroll back and forth to achieve the zoom function of channels and PTZ 3D.

Mouse Move

Select controls of the current coordinates to move.

Mouse Drag

Select area to detect.

Select area to shelter.

Select zooming function of PTZ control.

4.4 The Input Method

capitalization and the input of Chinese. Click the mouse to complete the input.”← “represents the backspace and “_ “represents a space.

In the input box, you can select figures, symbols, English The input interface of English:



figures:





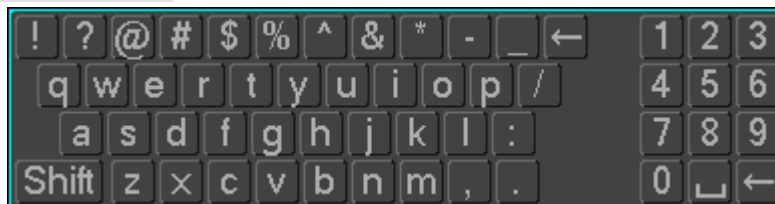



The input interface of Chinese:



4.5 Icon

4.5.1 The Screen Icons

-  : The channel is recording.
-  : The video of the channel is lost.
-  : Motion detection occurs.
-  : The channel is in monitoring and locked status.
-  : Adjust the size of the logo of the local audio output.
-  : Allow screens to round of the Tour.

4.5.2 Operation Icons



: Not selected.



: Be selected.



: The drop - down button



: Leave the interface.



: Cancel the settings.



: Set parameters.



: Save parameters.



: Restore the factory settings.



: Apply current settings to the system.



: Copy current settings to other channels.



: Enter the configuration interface.



: Select and configure the processing operation triggered by video detection or alarm.

5 Installation

5.1 Unpacking Inspection

When you receive the product, check according to the packing list in the box.

5.2 HDD Installation

Installation Preparation

Prepare a Cross Screwdriver.



Note: HDD quantity by each model's specifications shall be final, HDD capacity up to 64 TB.

Steps

Remove the metal top cover by removing two screws from the sides of the cover.

Place the hard disks on a flat table and tighten the screws.

Connect the power and the data lines to the HDD.

Reinstall the metal top cover and tighten the screws.

Caution

Only use the HDD specified by the manufacturer.

The HDD will be formatted automatically during booting and it may cause data loss.

The total duration of video data saved is decided by the HDD's capability and the DVR's parameters (recording setup, encoding setup). Please refer to the form in chapter 11.5.

5.3 Installation of the burner

Installation Preparation

Prepare a Cross Screwdriver.

Steps

Unscrew the screw on the side of the chassis and open the case cover.

Use a screwdriver to remove the bracket fixed in middle of the disk.

Open the front panel door and remove the baffle inside.

Connect the burner data cable and the power cord.

Fix the chassis cover.

Caution

The installation of the built-in burner is only for specific DVR and affects disk space for installation and interfaces.

5.4 Alarm/PTZ/Control Keyboard Interface

Alarm/PTZ/Control Keyboard Interface

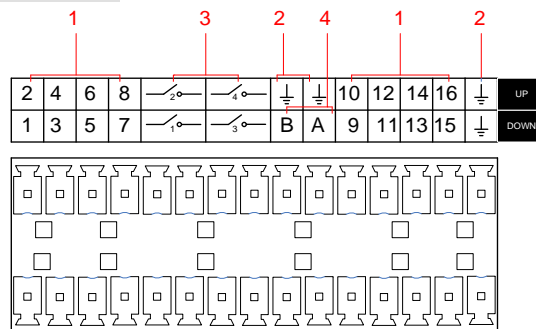

No	Name	Instructions
1	Alarm Input	Connect the positive end (+) of the alarm input device to the alarm input port (ALARM IN 1~16)
2	GND	Connect the negative end (-) of the alarm input device to the ground
3	Alarm Output	Connect the alarm device
4	RS-485	485 communication port. They are used to control devices such as PTZ. Please parallel connect 120TΩ between A/B cables if there are too many PTZ decoders



- Different models support different alarm input ports. Please refer to the specifications sheet for detailed information.
- Slight difference may be found on the alarm port layout.

Examples of alarm input connections

The alarm input is the switch quantity input. If the alarm input signal is not switch quantity signal but voltage signal, refer to the following connection:

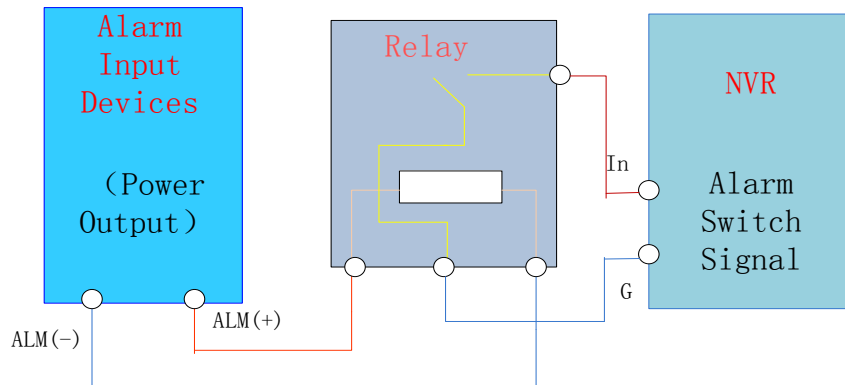

Examples of alarm output connections

When the alarm output connect with DC and AC load, please refer to the connection.

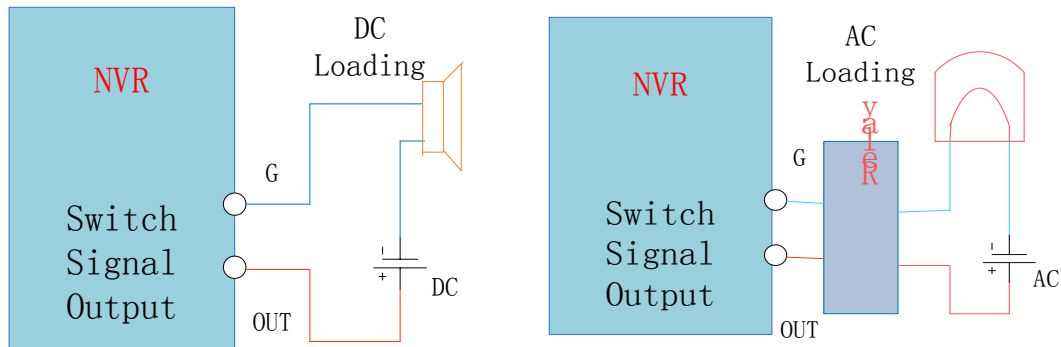

See details 7.2.5.

The Connection of the P/T/Z

The A, B interface of the PTZ decoder connect with A and B interfaces of the DVR's RS-485. 120Ω resistors should be paralleled in the remote A, B lines to reduce the distortion of the signal if a larger number of PTZs are connected.

See details 7.2.4.

Keyboard

The A, B interface of the Keyboard connect with A and B interfaces of the DVR's RS-485, [MAIN MENU]-[CONFIGURATION]-[P/T/Z], Protocol choose KEYBORAD. See below.

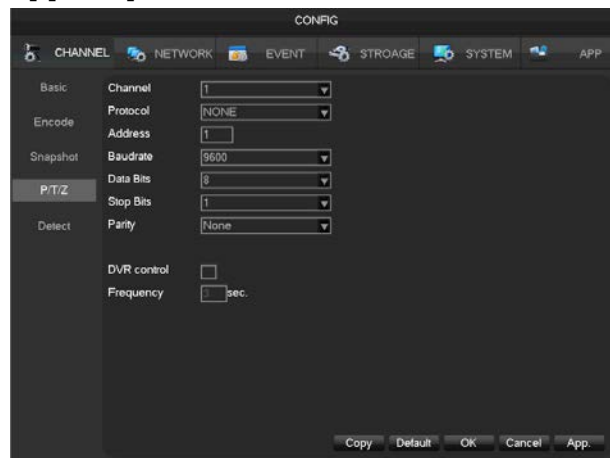

5.5 POE Connection

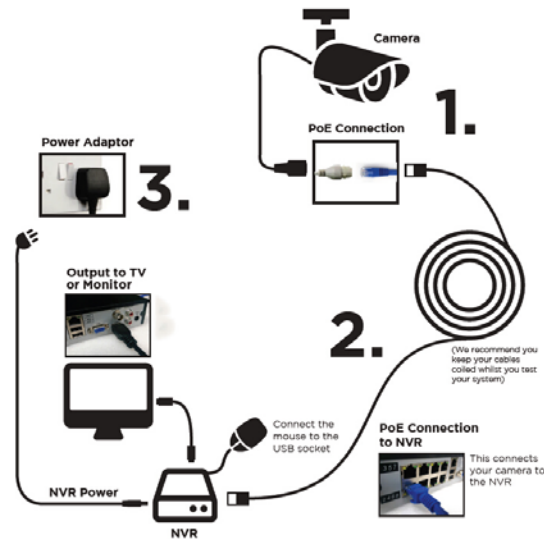

- Non-safe voltage 48V, please pay attention to electrical safety. Supply the NVR with the 12V DC power.
- IP Camera should support the POE.
- The theoretical distance of POE power supply should below 100 meters.

6 Basic Operations Guide

6.1 Power On and Off

6.1.1 Power On

Install the DVR/NVR correctly (as above) and then connect the power. The DVR/NVR LED should light up and the DVR/NVR will boot automatically.

The DVR/NVR will then automatically detect any connected hardware (cameras, monitors, etc.), this process should last about 30 Seconds. When this process has been completed the DVR/NVR will enter the multi-screen real-time surveillance mode.

If your hard drive is not properly connected, the following message will appear on your screen.

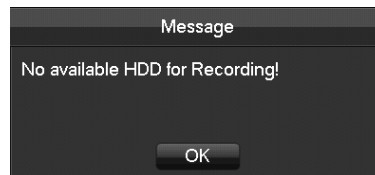

Note: Please do not use any type of power supply which is different from the power supply included in this kit.

6.1.2 Power Off (Shutdown)

Right mouse click -[Main Menu]-[Shutdown]



Note: Only change or attempt to reconnect the hard disk drive after shutting down the DVR/NVR.

6.1.3 Restart

Right mouse click -[Main Menu]-[Shutdown]-[Restart system]

6.1.4 Power recovery

Reboot after an outage or forceful shutdown, DVR will save the record before outage and return to the normal operation mode.

6.2 Start-up wizard

Quickly configuration, including P2P account&password setting, network configuration, intelligent mode selection.

Help Information

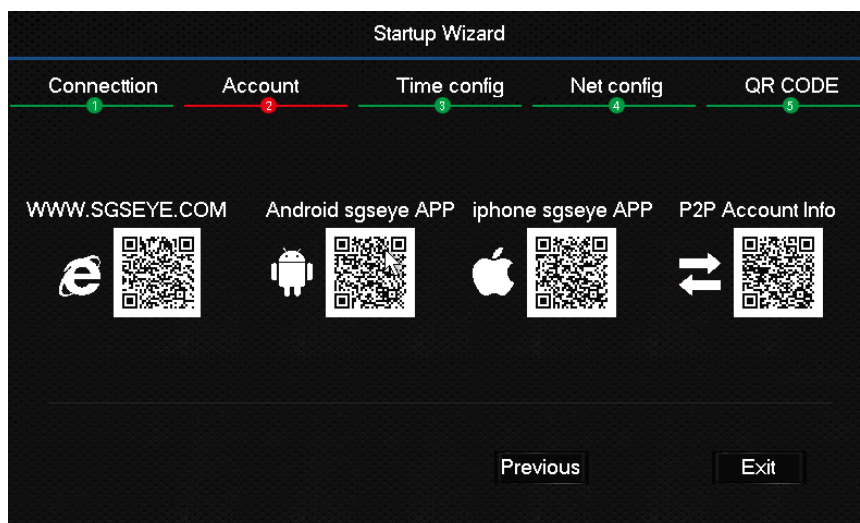

[QR code]From left to right: Web access address, Android APP address, iPhone APP address.

[Network Connection Status]The current network status.

[P2P]P2P account&password setting.

[Start-up wizard]Tick Start-up wizard Enable.

Network configuration

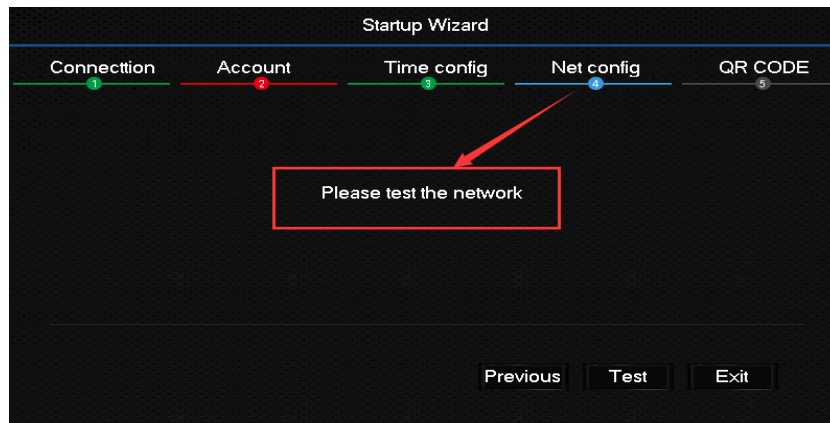

[DHCP]Tick DHCP Enable.

[IP address]Enter the number or press up&down button(▲▼)to change the IP address and [Subnet Mask] and [Gateway]。

[First DNS Server]DNS server IP.

[Alternate DNS Server]DNS alternate IP.

[QR code]Scan it and shows P2P account, login with mobile APP.

Account



[Add Users] Add a new user

[Modify User] Modify the user name, groups, rights

[Add Group] to add a user group, and configure the user group right.

[Modify Group] Modify the permissions belong to Group

[Modify Password] Modify the Login password

Intelligent mode selection



[Intelligent mode selection] Intelligent mode selection.

6.3 Add Device

If the device supports IPC, should be added to IPC first. We offer three ways . And support different protocols.

6.3.1 Channel Mode Switch

Local channels compatibility with network by the channel mode switch.

Login[main menu]- [Channel]-[Mode Switch]Enter the administration page.

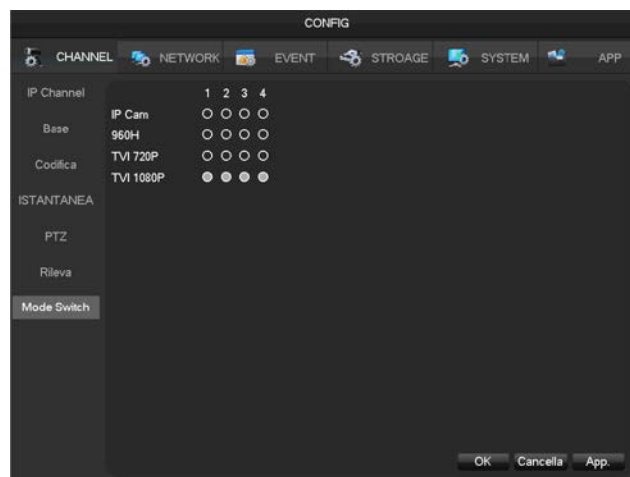

1. Local channel switch network channel:

Click the start channel number, then the channel number switch the network channel(Contains the channel), click the[ok], restart your device to complete the switch. \For example: 2 channel choice network, as shown in the figure below, the 2-4 channel have switched the network channel

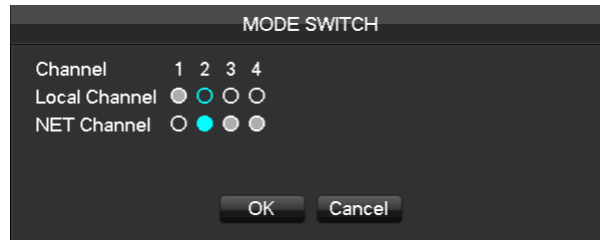

2. Network channel switch local channel:

Click the end channel number, then the channel number switch the local channel(Contains the channel), click the[ok], restart your device to complete the switch.

For example: 2 channel choice local channel, as shown in the figure below, the 1-2 channel have switched the local channel

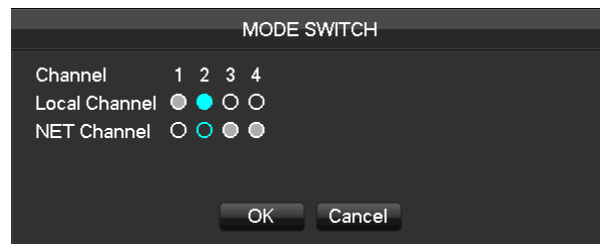

If the preview screen appears shown as follow image:

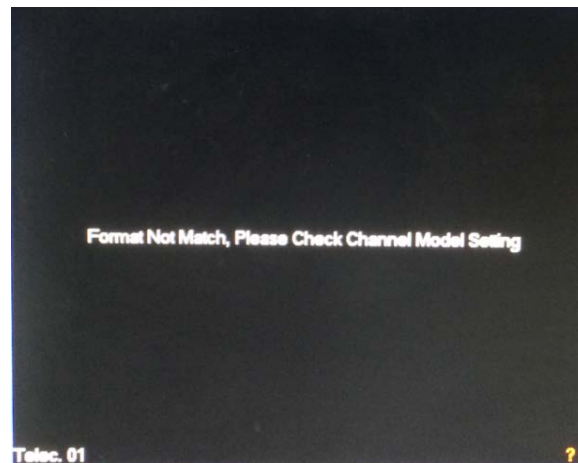

Then the channel does not match the resolution of the camera, Please enter in the [main menu] → [Channel] →[mode switch] to configure the correct resolution

6.3.2 QUICK ADD IP CAMERA

In preview screen, move the mouse to the network channel, it will show "+" sign, left-click to enter the following Menu:



Search add

Click [Filter] to select the protocol

Click [Search] to search

Click “+” to add device

Manual add

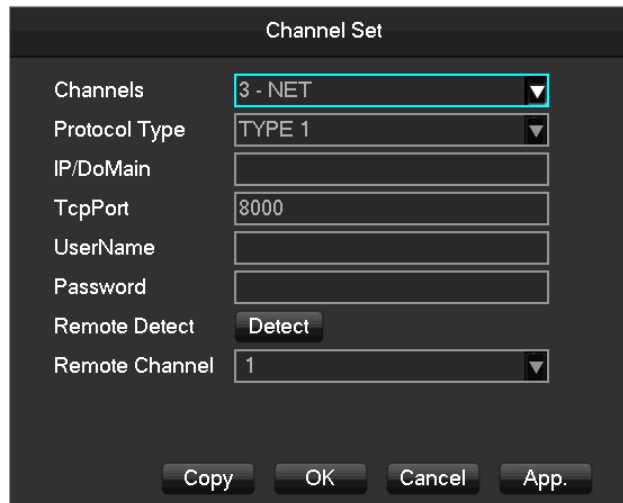

[Channels] Choose one channel.

[Protocol] Choose protocol supported by the device.

[IP/ Domain Name] Input front device IP address or domain name.

[Port] Input front device TCP port.

[Username] Input front device username.

[Password] Input front device password.

[Remote Detect] After completing the above settings, click detect button to check connection status.

[Ping] Check whether the current network is to be connected.

[Remote Channel] When the front device includes multiple channels, choose one channel for it.

Click “App” button to finish.

6.3.3 Adding Menu

The equipment with input function use network channel management page for add or delete the equipment and set

the front-end configuration.

There are two ways to login[IP Channel]

1、Living preview, click the button below[IP Channel]

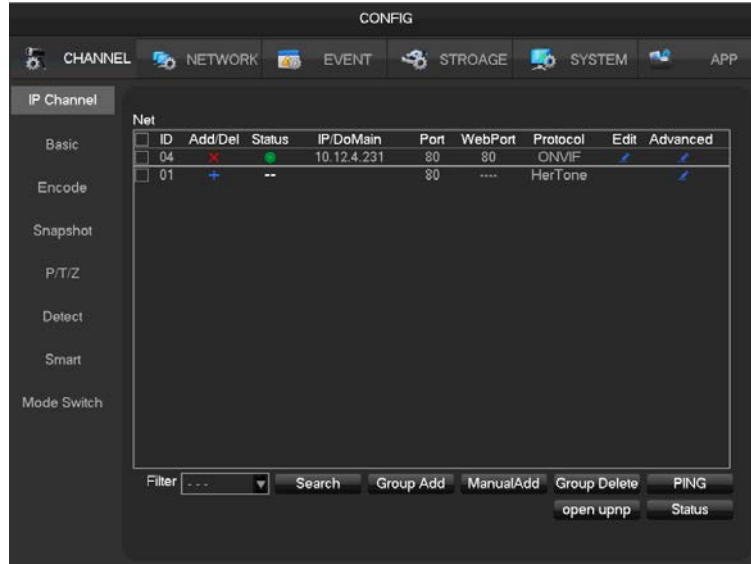

2、[Main Menu]-[Channel]-[IP Channel]

Network channel management in the following page



[Check box]click the check channel,double click can deselect the check channel,Click the title bar to achieve selection, double click can deselect all .

[Serial number]Display the network channel number to add equipment serial number.

[add、 delete]clickDelete the current network equipment.clickadd the network equipment.

[status]Show the current channel connection status: Connection is normal, ID or Password is wrong, the equipment is offline, User is lock。

[IP address/domain name]Display the equipment's IP address/domain name.

[Port]Display the port number

[Web Port]Display the web port number.

[Agreement]Display the connection agreement.

[Edit]Configure the channel information, show in6.3.6

[The front-end configuration]Configuration front camera's parameters

We provide three ways to add device, automatically, searching,manually add the device.

6.3.4 Automatically added

No configuration, the device is automatically added.

[Main Menu]-[Channel]-[IP Channel]-[Open UPNP]



Note: The device should support UPNP and should be in the same LAN.

6.3.5 Searching Added

Search all the IPC can be added via internet and then choose to add. To do the following.

Enter[**IP Channel**]

Click[**Filter**]to choose protocol

Click[**Search**]

Click+ to add device or Right click[**Add to**]choose the channel you want or tick the devices you want to add,then click[**Group Add**].

6.3.6 Modify channel configuration

Enter [IP Channel].

Click “Edit ” button of device.

Click “OK” button to finish.

6.3.7 Configure Front Device

Basic configuration, encoding configuration, snapshot, network and motion detection of front device can be set in NVR.

Enter Net Channel Management menu.

Click “Front Set ” button of device.

BASIC

Front Set

Basic Encoding Snapshot NetWork Detection

Channels Choose 4 - NET

IPC Channel Name IPC

IPC Current Time 2016 - 03 - 10 15 : 04 : 43

IPC Time Zone GMT+08:00

Syn With NVR Time

IPC Control Reboot IPC

Refresh OK Cancel App.

[**Channel Choose**]Choose a channel.

[**Channel Name**]Modify current channel name.

[**IPC Current Time**]Set IPC time.

[**Time Zone**]Set time zone.

[**Time Sync**]Enable IPC time sync with NVR.

[control IPC]Click the prompt whether restart the IPC, [OK]Restart the IPC, [Cancel]Return.

Encoding

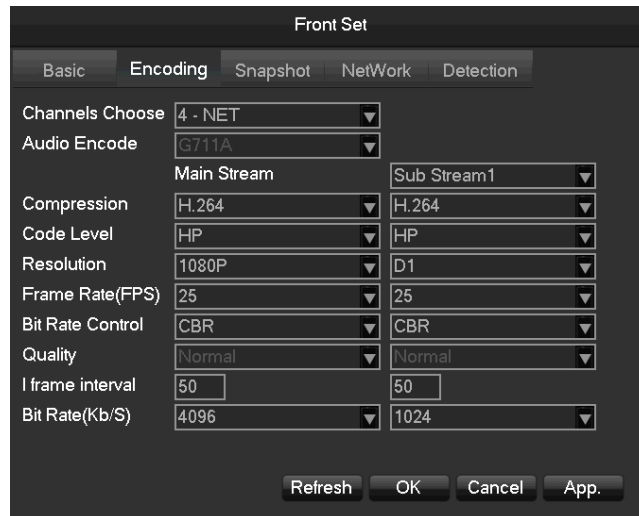

[Channels Choose]Choose one channel.

[Audio coding]Select the current audio encoding

[Code Level]H.264

[Resolution]choose main resolution and sub resolution.

[Frame Rate] 1~25FPS/PAL,1~30FPS/NTSC

[Bit Rate Control]Choose CBR or VBR. When choose CBR, bit rate can be set. When choose VBR, image quality can be set.

[Picture Quality]Choose the picture quality by the Variable stream, there are 6 range to choose.

[I frame interval]Set interval of adjacent frames. Max is 150.

[Bit Rate]Choose 1280,1536,1792,2048,3072,4096,5120,6144,7168,8192 or set by yourself.

Snapshot

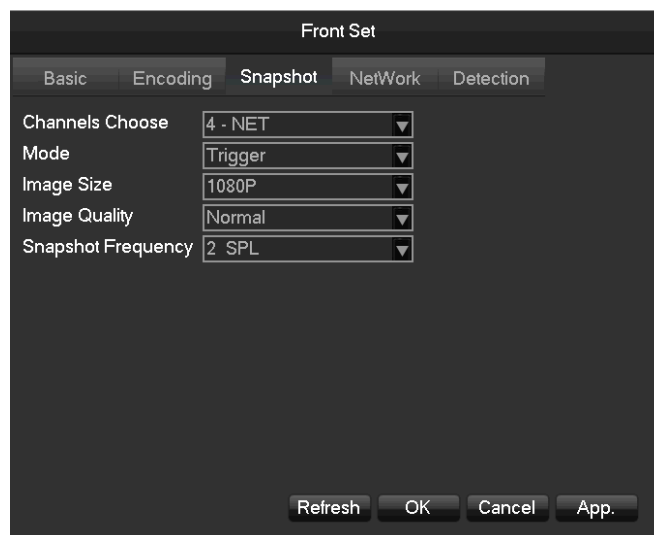

[Choose Channel]Choose the channel to be modified.

[Shopshot Mode]trigger the two mode of shopshot and timing shopshot,the timing shopshot that you must be selected.

[Picture resolution]Set the captured picture resolution.

[Picture Quality]Choose the picture quality, there are 6 range to choose.

[The frequency of highest shopshot]Support 1sec./pcs.~8sec./pcs 8 ranges of shopshot to choose.

Network

Front Set

Basic Encoding Snapshot **NetWork** Detection

Channels Choose 4 - NET

Get the address successfully

IP Address 10 . 12 . 4 . 231

Subnet Mask 255 . 255 . 255 . 0

Gateway 10 . 12 . 4 . 1

First DNS Server 8 . 8 . 4 . 4

Alternate DNS Server 8 . 8 . 4 . 4

MAC/Serial 4c:11:bf:a8:35:c8

Refresh OK Cancel App.

[Channels Choose]Choose one channel.

[IP Address][Subnet Mask][Gateway]Set IP address, subnet mark and gateway for the device.

[First DNS Server]Set DNS server IP address.

[Alternate DNS Server]Set standby DNS server IP address.

[MAC/Serial] Show MAC address of front device.

Detection

Front Set

Basic Encoding Snapshot NetWork **Detection**

Channels Choose 4 - NET

Enable

Sensitivity Middle

Set Area Setting

Refresh OK Cancel App.

[Channels Choose]Choose one channel.

[Enable]Enable motion detect alarm or not.

[Sensitivity]Set sensitivity level for motion detection.

[Set Area] Set area for motion detection.22*18 area can be set.



:Make sure that protocol for front device supports motion detect function.All settings are for front device.

6.3.8 Delete Front Device

Enter Net Channel Management menu.

Click Delete the equipment.

Checkmark several device and click “Batch Delete” to finish delete.

6.3.9 Others

Right click in added device.



[Front Set] Reference 6.3.7

[Automatic Detection]Check connection status of the current channel.

[ShortCut PING] Check the current channel network whether is connected

[Channel exchange]Exchange position of channels.

Right click device that hasn't be add.



[ShortCut PING]Check the current equipment whether is connected

[Add To]Add device

6.4 The event of configuration

The events is that the user had expected all the facts, the device can handle events types include: traditional alarm events, equipment abnormal events, intelligent analysis. Configure an event all by: the event type, rules, protection plan, linkage of four parts.

6.4.1 Detect configuration

The traditional alarm events, include video detection (motion detection、video loss、Video shade) and external alarms.

[main menu]-[Channel]-[Detect]Enter the configuration interface.

Video detect

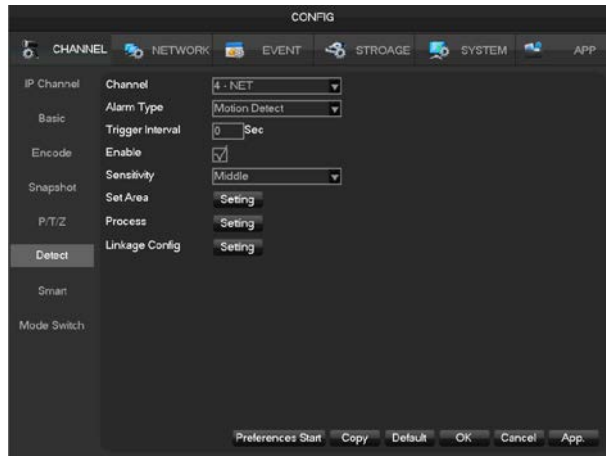

[**Channel**]Select a channel.

[**Alarm type**]motion detection, video loss and video blind.

[**Motion detection**]detect the motion in the picture, and send alarm according to setting.

[**Video loss**]detect the video loss and send alarm according to setting.

[**Video blind**]detect the video which was covered and send alarm according to setting.

[**Enable**]control the alarm open and close

[**Sensitivity**]highest, higher, middle, low, lower, lowest

[**Set area**]there are totally 22*18=396 area can be set, which needs motion detection.

[**Process**]Set the alarming time, linkage and the handling method.

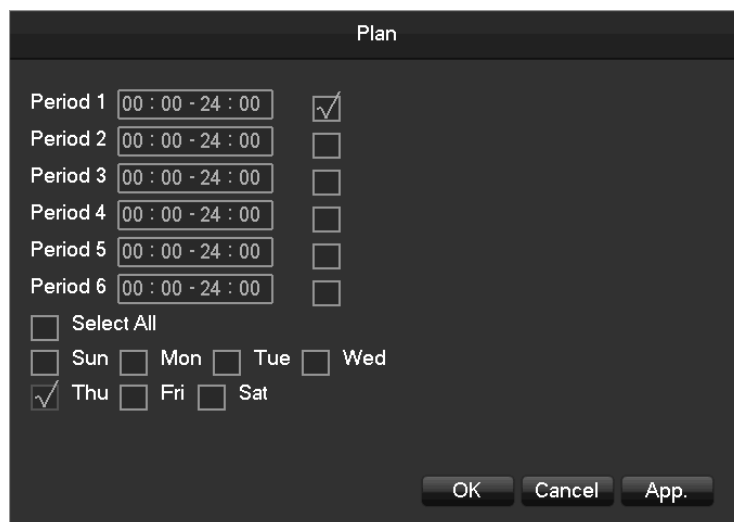
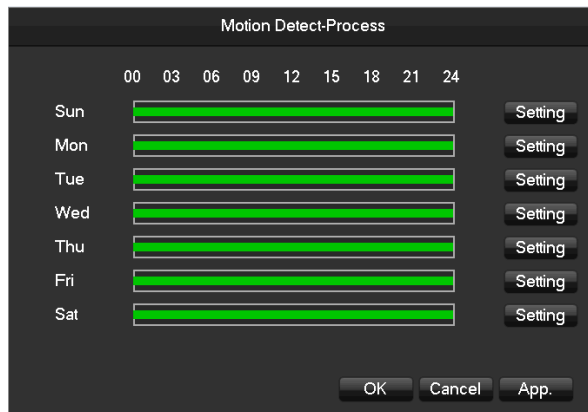

[**set linkage**]show in the appendix 9.1 about set alarm linkage.

[Preview] it will show a test on the current setting

[Copy]copy the setting to other channels

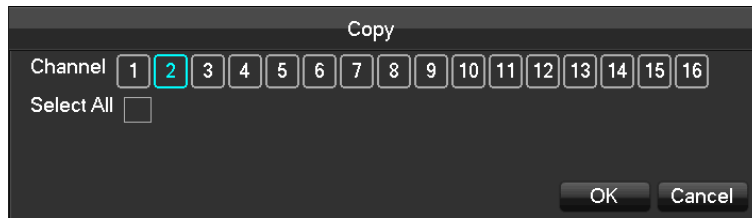

6.4.2 Intelligent analysis

A part of equipment support face detection and parameter detection function,the recorder analysis the real-time video without the camera.

Smart mode Selection

If the equipment support intelligent analysis,enter the page of smart choice by[main menu]-[Channel]-[Mode Switch],choose the channel to open the intelligent analysis function or change the intelligent function of the equipment.

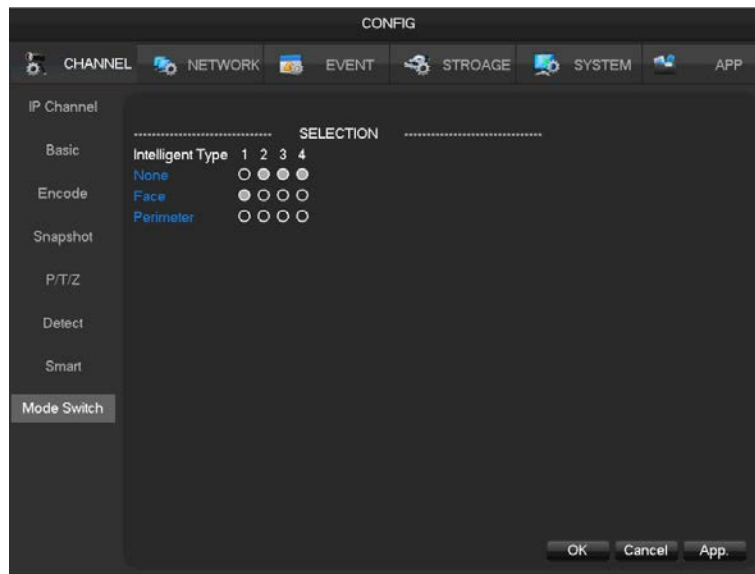

Face detection configuration

When a device open the face detection function, enter the page of face detection by [Channel]-[Smart]:

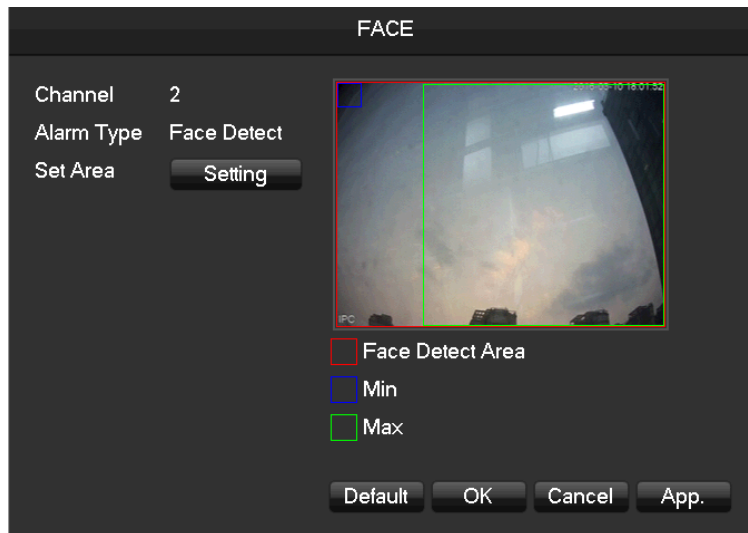

[Channel] Select Intelligence channel

[The minimum]the minimum area of the face detection,blue scope refer to the minimum area of the face detection,the face can't be picked if the face less than the minimum area of the face detection,please Please according to the practical use of scene and the expected area of the face detection to set the function.

[The biggest]the biggest area of the face detection,green scope refer to the biggest area of the face detection,the face can't be picked if the face bigger than the biggest area of the face detection,please Please according to the practical use of scene and the expected area of the face detection to set the function.

[red scope]detection area,after set the function,the equipment only can detect the area of the face,Can effectively reduce false positives and omission.

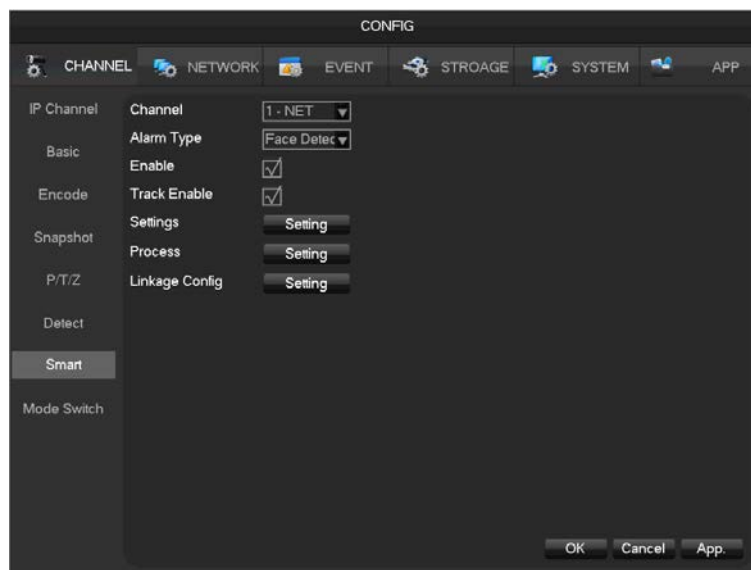

[Chanenl] Select Intelligence channel.

[Alarm Type]Face Detection(Capture faces and alarm) or Perimeter(Analyzing move target forward, backward across the line and invading the region and left and generates an alarm)

[Enable] Open intelligent analysis

[Track enable]Tracking control box on and off

[Setting]set the biggest or the minimum area of the face detection.

[Process]choose the protection plan,enter the editing plan that we can configure the time of protection every day.

[linkage Config]show in the appendix 9.1 about set alarm linkage

[set linkage]show in the appendix 9.1 about set alarm linkage.

[More configuration]

[Resolution]According to the front end of the highest resolution, set the difference of the resolution. For example: the front 1080P, can Analysis of the four resolution of 1080P, 720P, D1, CIF .

Perimeter Intrusion detection configuration

When the equipment open the perimeter analysis function,can enter the perimeter setting page by**[Channel]**-Alarm Type-Perimeter

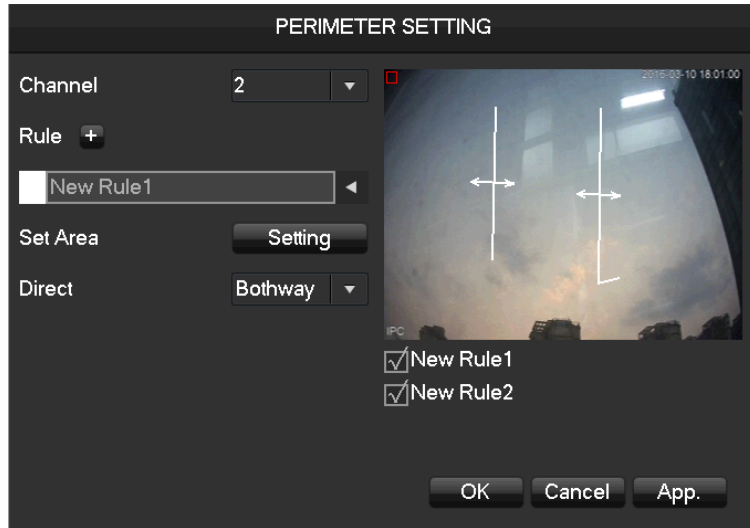

[Channel]choose the channel of the perimeter analysis.

[Rule] click “+” add rule

[Set area]set current rule line what you choose

[direct]set the fold line rules to sure the detection direction.



Note: if there is no channel to analysis the perimeter detection,you can set the function by**[Channel]**-Alarm Type-Perimeter

[rule]

click[+]make the new perimeter analysis rule.

Click the color box to set the line of color rule,show in the picture:

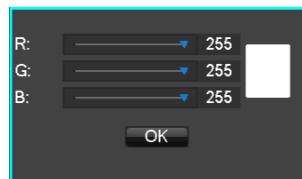

Click the rule name can modify the name.

Click the drop -down menu to choose the other rule,then can delete the rule.

6.4.3 Alarm input

[Main menu]-**[Even t]**

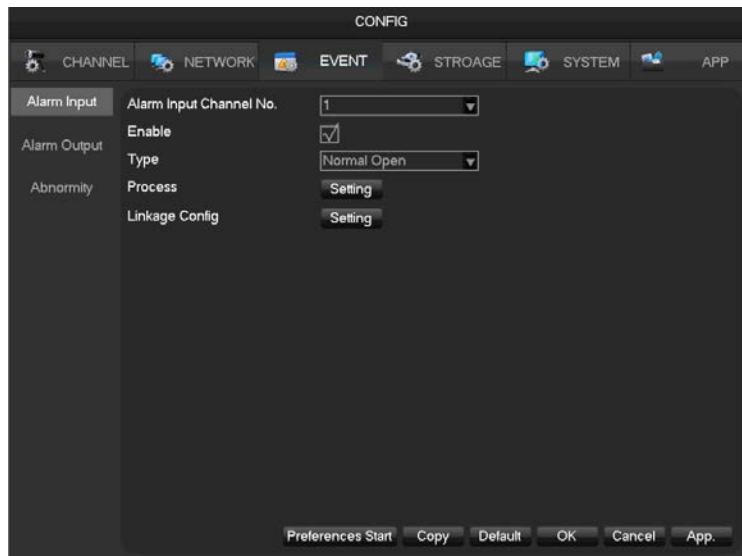

[Alarm input channel No.]: select a channel

[Enable]: control the open and close of alarm

[Type]: choose Normal open and Normal close

[Process]Set the alarming time, linkage and the handling method.

[set linkage]show in the appendix 9.1 about set alarm linkage.

[Preview] it will show a test on the current setting

[Copy]copy the setting to other channels

Alarm Output

On the real time preview picture, right click and choose **[Alarm output]**, or enter **[Main menu]-[Event]-[Alarm output]**



[Schedule]Alarm output is controlled by the device's linkage setting.

[Manual]Alarm output is on and the status is active.

[Stop]Alarm output is off and the status is inactive.

[Status]Current status of alarm output



Note: some models do not have alarm output, please refer to some relative data sheet.

6.4.4 Equipment Abnormal

Provide multiple equipment abnormal monitoring function, and it can do the corresponding alarm linkage of equipment abnormal events.

[main menu]-[Event]-[Abnormity]Enter the configuration interface as shown in the figure below:

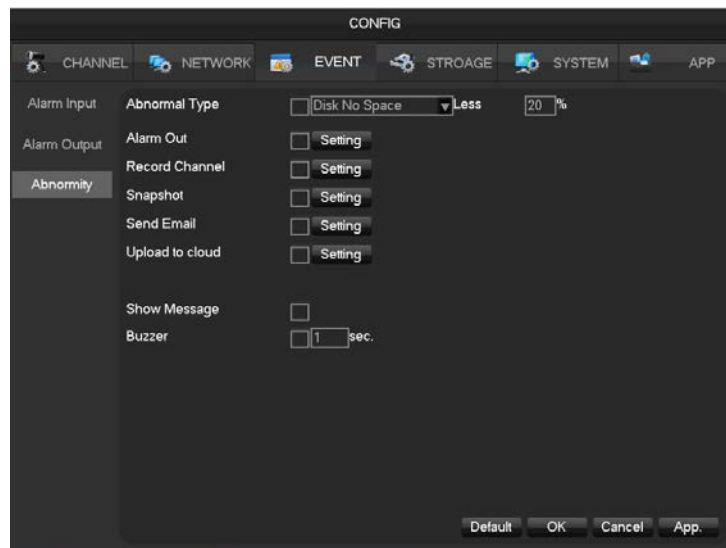

[Exception type]

[No Disk]Alarm when HDD is not present or cannot be detected.

[Disk low Space]Alarm when hard disk capacity is lower than setting.

[Network Failure]Alarm when network is not connected.

[IP Conflict]Alarm when IP address conflict.

[Disk Error]Alarm when there is error in reading and writing hard disk. .

Process

[Alarm Output]、[linkage record]、[snapshot]、[Send Email]、[show message]、[Send to network drive]、

[buzzer]

Show in the appendix 9.1 about set alarm linkage.

6.5 Log in/Log out

Log in

Right click to log in menu. Enter username and password.

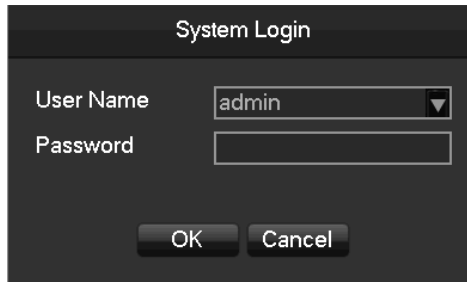

Default users

User Type	Name	Default Password
Administrator	admin	123456
User	user	123456
Hidden	default	



If input incorrect password three times, device will sound. If input incorrect password five times, account will be locked. For security purposes, please change the default password and the user name.

Log out

1. When over the standby time, log out automatically.
2. Enter [Main Menu]-[Shutdown]-[Log out]

6.6 Preview

6.6.1 Live Preview

In live monitoring, there are date, time, channel name, recording status and alarm status.



Control screen switching by front panel, remote controller and mouse.

When alarm occurs, it will show message like external alarm, video loss, video blind, motion detect, network status and IP address conflict.



Quick Operation

Switch single or multiple screens	Double left click in screen to single channel and Double left click to return
Adjust channel order	Drag the channel to the wanted position
Add device	Click [+] in one channel to enter add menu. Please refer to 6.3.2 about more details.

6.6.2 Channel Toolbar

When mouse move on the top of windows, it will show channel toolbar as follows:

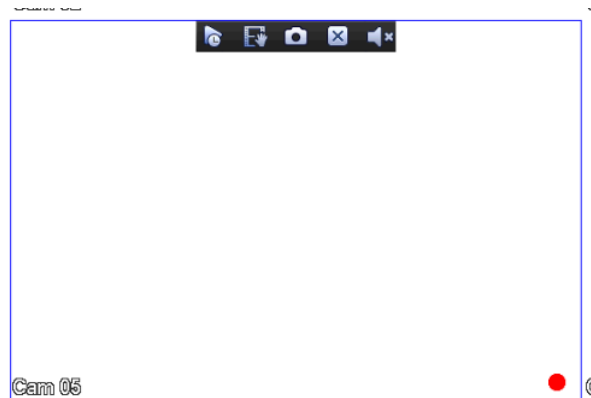

: Real-time playback in five minutes.

: Backup the last five-minute video to U disk, backup time can be setted.

: Snapshot and backup to U disk.

: Channel toolbar is temporarily closed within 30 seconds



Set the volume of sound.

6.6.3 Right Click Menu

Enter real-time monitoring and right click menu.

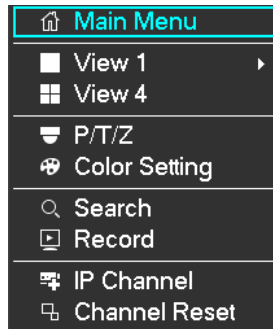

Screen Division

Choose single screen, four screens, nine screens or sixteen screens to view.

PTZ Control

Configure PTZ. Please refer to 7.2.4 and 6.3 about more details for analog camera and IP camera.

After done configuration, click “PTZ Control” in corresponding channel to control PTZ.



Direction, steps, zoom, focusing, iris, preset points, cruising between points, patrols, sweeping the boundary, calling an auxiliary switch, light switch, horizontal rotation of PTZ can be controlled.

[SIT] means quick location button. Make sure that the protocol supports this function. After enter the page, click a point in screen. PTZ will turn to the point and move the point to centre of screen. Besides, It also supports 4 to 16 times zooming when drag mouse in the quick location page.

The [Step] is mainly used to control directions. The figure can be set from 1 to 8. Click or to adjust zooming, sharpness and brightness.

PTZ can control eight directions. But front panel only can control up, down, right, left.

[Present] Enter present figure in box and click “Present” button to call present function.

[Tour] Enter cruise figure in box and click “Cruise” button to call cruise between points function.

[Pattern] Enter patrol figure in box and click “Patrol” button to call patrol function.



:gray button means don't support the function.

Configure [Present]

Present is for recording the next position, which is marked by a figure. Call the figure to enable present function.

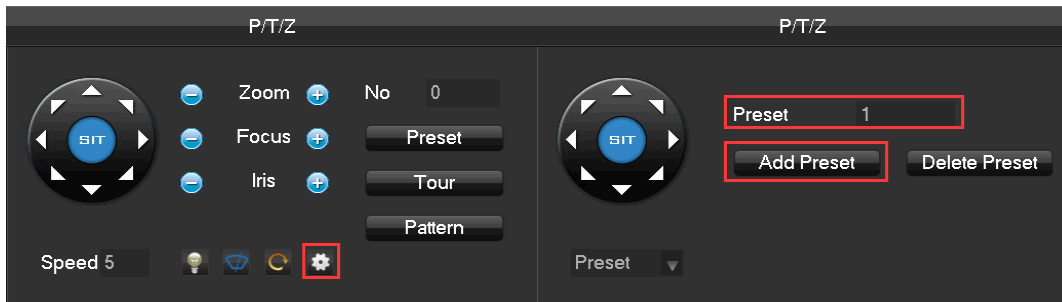

Configure [Tour]

Tour includes several present points and is marked by a figure. When call the figure, present point will run one by one.



Configure [Pattern]

Pattern is consisted of PTZ rotation path and is marked by a figure. Call the figure to enable patrol function.

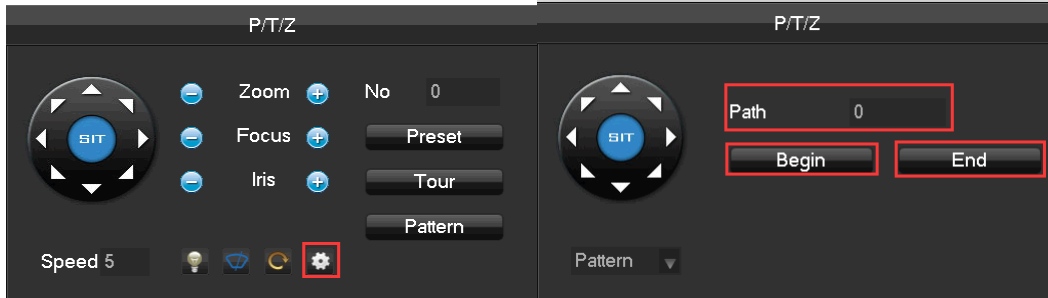

Color Setting

Adjust the specified screen (single screen) image color hue, brightness, contrast, saturation, gain and white-level parameters set two time periods according to the local environment difference between day and night for each adjustment period set, the device will automatically switch to the best video quality.

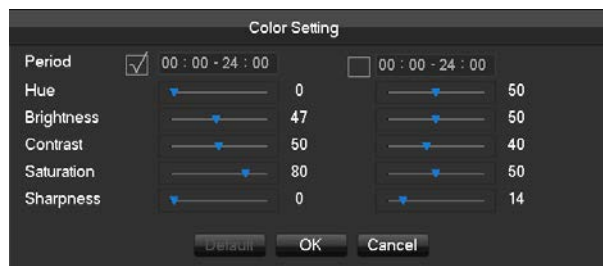

[Period]Two periods can be set according to ambient light during the day and night, device will automatically switch configuration time. Need to select the Enable box.

[Hue]Adjust according to image color cast

[Brightness] Visual image brightness, according to the environment, reduces or increases the brightness of the image brightness to make the image relatively clear.

[Contrast] Adjust image of black and white in proportion, the greater ratio, the brighter image.

[Saturation] Image color purity, the greater value, the more colorful images.



Note: Different mode different function

The Video Inquiry

Refer to 6.5 Search

Manual Record

In real-time monitoring screen, right click and select **[record]** to enter the interface.

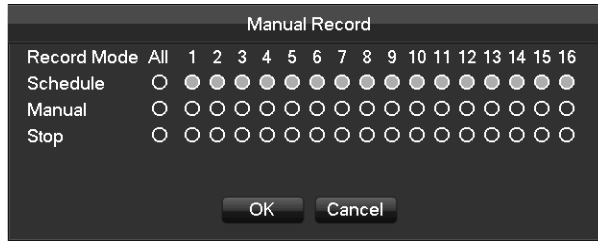

[Manual] It has the highest priority and corresponding channels will record for whole days after chosen.

[Schedule] Record according to recording configuration.

[Stop] Stop recording.

To change a channel state of the video, at first check the video channel state is in selected or not, then use the mouse to click, or use **[◀]** and **[▶]** to find the channel and use **[▲]** and **[▼]** to switch the video channel state.



Note: Select all channel and enable can change the video state of all channels at the same time.

Reset the channel order

Click to reset the default channel order.

6.6.4 Task Bar

Enter from the main menu and provide some quick operation.



The Screen Switching

To implement screen switch function



Above single, four, nine and sixteen channel.

PTZ control



Brings up the PTZ control Menu

Refer to 6.4.2 PTZ control of the right-click menu.

Record Search



Click to select the Searching interface

Refer to 6.5 Search

Manual Record

 Click to select manual record interface

Refer to 6.4.2 Manual record of the right-click menu.

NET Channel Management

 Click to enter Net channel interface

Refer to 6.3

Alarm Status

 Check the recent alarm status, click to show the following alarm message

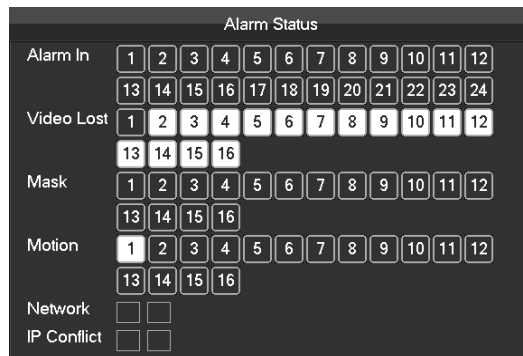

Alarm output

 Alarm output menu

Refer to 7.2.5 Alarm output of Alarm menu

Intelligent window switch

 Intelligent window switch

When the system is face/perimeter analysis status, click to close the intelligent window in the right side of real-time monitoring screen and click again to open it.

Conceal function

 Color setting

Refer to 6.4.2 Color setting of the right-click menu.

 Reset the channel order

Click to reset the default channel order.

 Taskbar Configuration

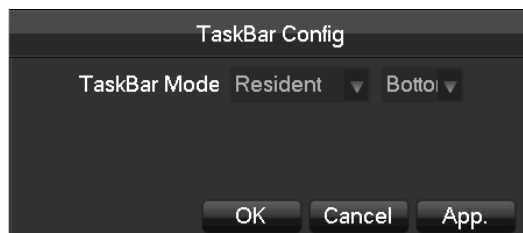

[Task Bar Mode]Choice of Resident or Automatically, Choice of Bottom and TOP.

6.7 Search

6.7.1 Search

In real-time monitoring screen, right click and select[search]to enter the searching interface.

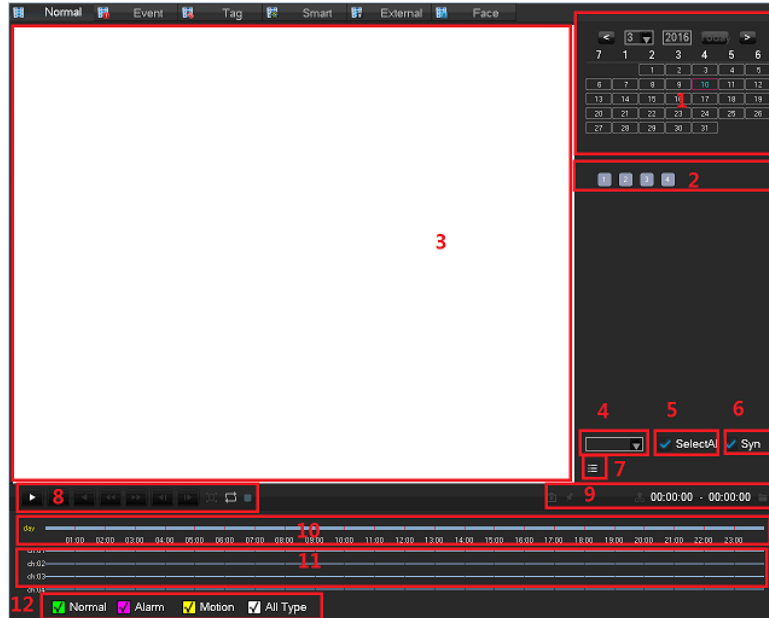

Record Search interface description:



Index	Type	Description
1	Choose the date	Select the time and date to search records.
2	Select channels	Choose the channels for querying.
3	Playback window	Playing video.
4	Time bar channel	When you select the number of channels is more than 4, a channel number value for the timeline display
5	All Channel Select	All select, all cancel
6	Synchronization	Achieve the playback of each channel's record is of synchronization in time and of consistency in operations.
7	List	Show the status information of channels' video recording within one day by green, red, yellow.
8	Playback control	Full screen, Loop, Stop/Play、Pause、Fast、Slow、Back、Previous Frame、Next Frame.
9	Channel number	Select the channel number.
10	Event list	Show all events and time
11	Timeline display	Green, red and yellow colors show the video recording in the one day
12	Search Type	128 video records are shown in the list. Type: R—normal record, A—alarm record, M—motion

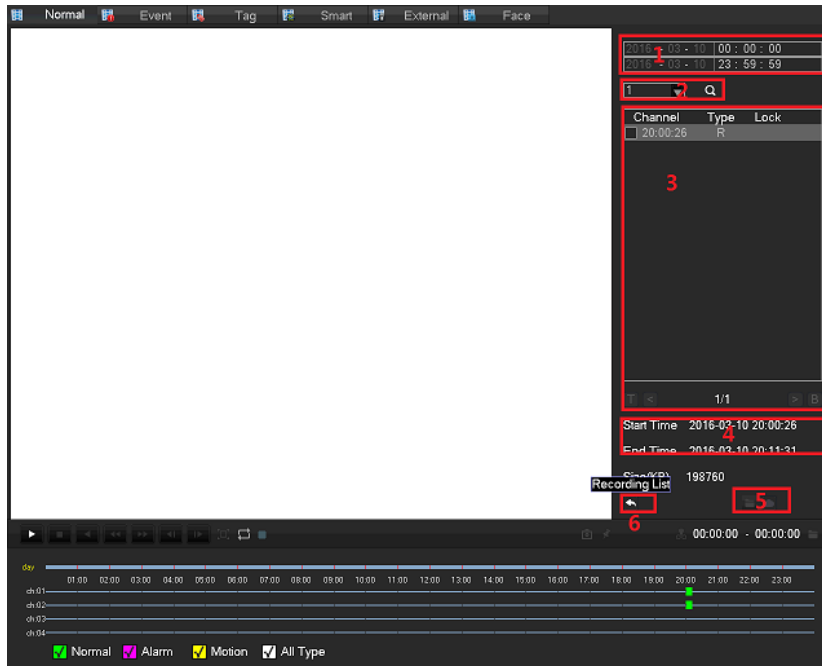



	detection record.
--	-------------------



Key	Type	Description
1	Time	Choose video query time
2	Channel	Select the desired query video channel
3	File	Query channel video display a list of files
4	File information	Display start time for a single video file, the end time, and video file size.
5	Backup	In the file list box, select the user needs to back up files in the list box playing "📁" to  check, and then click the button (backup) or (uploaded to the cloud disk), the backup operation menu appears, click the Start button, users can also do not want to cancel the backup files in the backup operation menu before you want to cancel the file list box cancel "✓".
6	Back	Exit File List

Playback Control:









Key	Description	Remark
Video playback: Fast-forward Key### 	Under playback mode, pressing this key, you can get a variety of fast cycle switching speeds; fast-forward button can be used as slow-release button reverse switch key.	Actual play rate based on version
Video playback : Slow key ### 	Under playback mode, pressing this key, switch cyclically support a variety of slow-release rate, slow release button can be used as fast-forward button reverse switch	

	key.	
Play/pause ▶/ ###	Play/pause switch when slow-play	
Backward: Backward key ### 	Single left click backward key	To play backwards and single click again to stop back run under common playback Rewind or single-frame playback, press the play button ▶/### to enter the normal playback .
Manual single frame playback 	single frame playback by clicking ### and ###when common playback pause	
	Full screen	
	When the loop is turned on, the day after the end of the video playback, video playback file start over again	



Note:

- 1.The player playback control bar shows file playback speed, channel, time, playback progress and other information.
- 2.Playback speed and rewind function are related to DVR version, and please prompt on the player panel shall prevail.

key sequence	explain	Remarks
Snapshot: 	When Playback, left-click on the icon, the snapshot of focus on window will back up to the U disk	Insert U disk, enter Search , supports a maximum resolution of 1080P
Tag: 	Left-click the icon, you can add tags to focus channel	set the tag name letters, numbers, special characters, the total length of no more than 31 characters. The tags can be used to add labels to retrieve.
Cut: 	Left click  , start to cut record, Starting time: click  focus window, icon turn to  ; left click again  complete cutting, End time: click  focus window。After finish cutting, click  to	If the focus of the shearing process channel change, places the focus of the channel when the end of the shear cut as a video channel. Shearing process can playback control.

	back up record, or right click to exit cut feature.	When the cut end time is earlier than the start time cut, cut start time automatically reversed.
--	---	--

6.7.2 Event Search

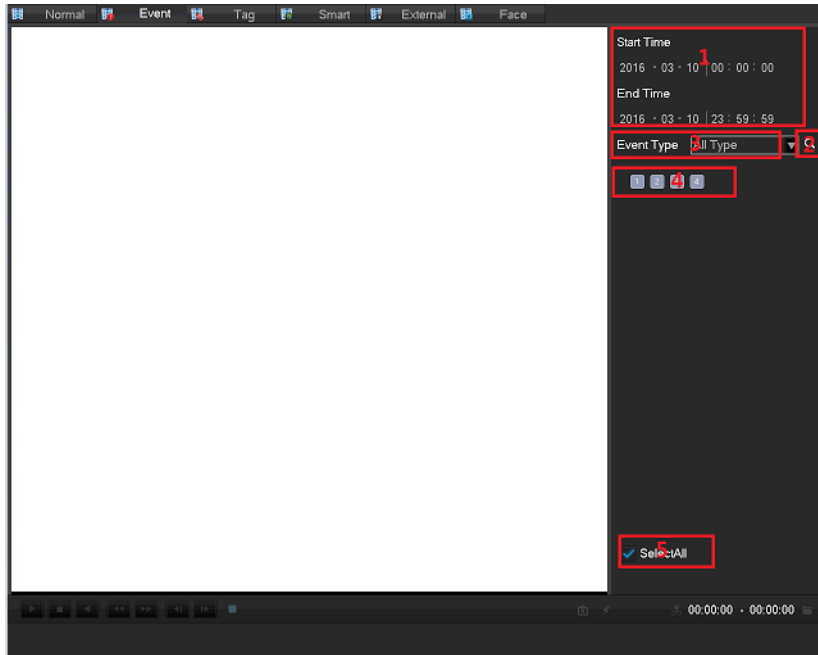

Index	Type	Description
1	Play Timeline	Display the progress bar of the current event
2	Search	Search record
3	Event Type	Select the type of event
4	Channel selection	Select the channel
5	Select all channel	Select all channel

Select the channel, start time, event type, click on the retrieval button to pop up a list of events as shown below

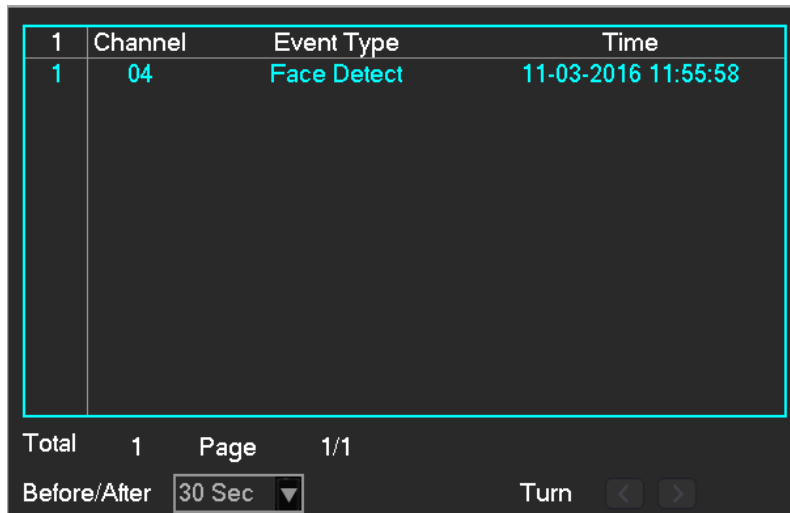

Event List Showing 10 event, to display the event channel number, event type, time,time of occurrence. List of events can flip through page keys. Double-click the event list for playbackdirectly.

The default time of 30 seconds before and after the event to play video files, can be configured to around 30 seconds, 1 minute, 5 minutes, 10 minutes

6.7.3 Tag Search

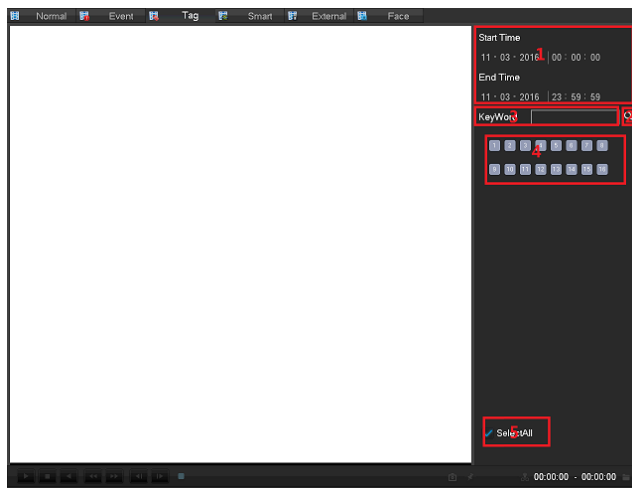

Index	Type	Description
1	Play Timeline	Display the progress bar of the current event
2	Search	Search record
3	Event Type	Select the type of event
4	Channel selection	Select the channel
5	Select al channel	Select al channel

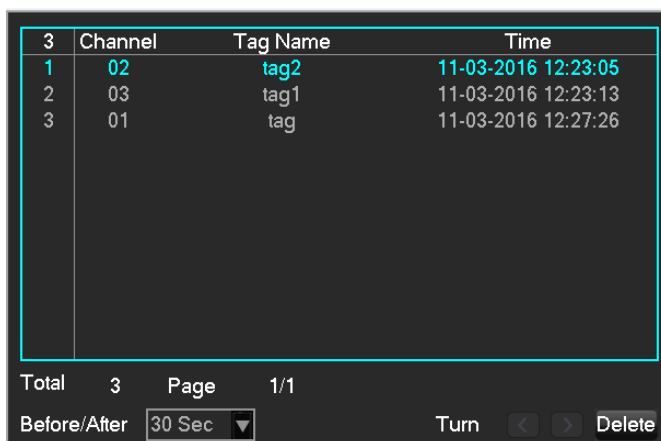

6.7.4 Smart Serach

Intelligent playback that video playback time, according to the input retrieval conditions, video analysis, quickly locate qualified video, and playback.

Currently our DVR, TVR device supports retrieval based on intelligent motion detection playback area.

Enter the smart playback interface, the interface as shown in FIG.

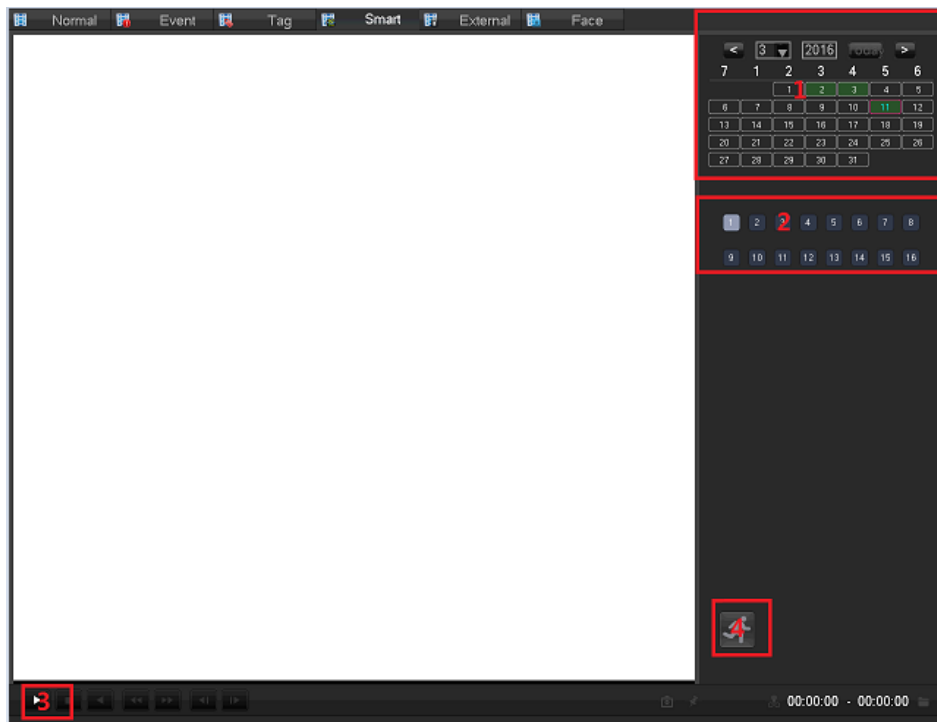

Intelligent playback using the following process

- 1, 1 position, select the desired search date.
- 2, position 2, select the desired search channel (radio).
- 3, left-click on the third position to start playback.
- 4, left-click on the icon position 4, select dynamic inspection area.
- 5, full-screen setting area is completed, the right mouse button to exit the configuration.

Complete search, video recording shall be the date the presence of all the moving subject information of the channel region is configured to display on the timeline.

6.7.5 External Search

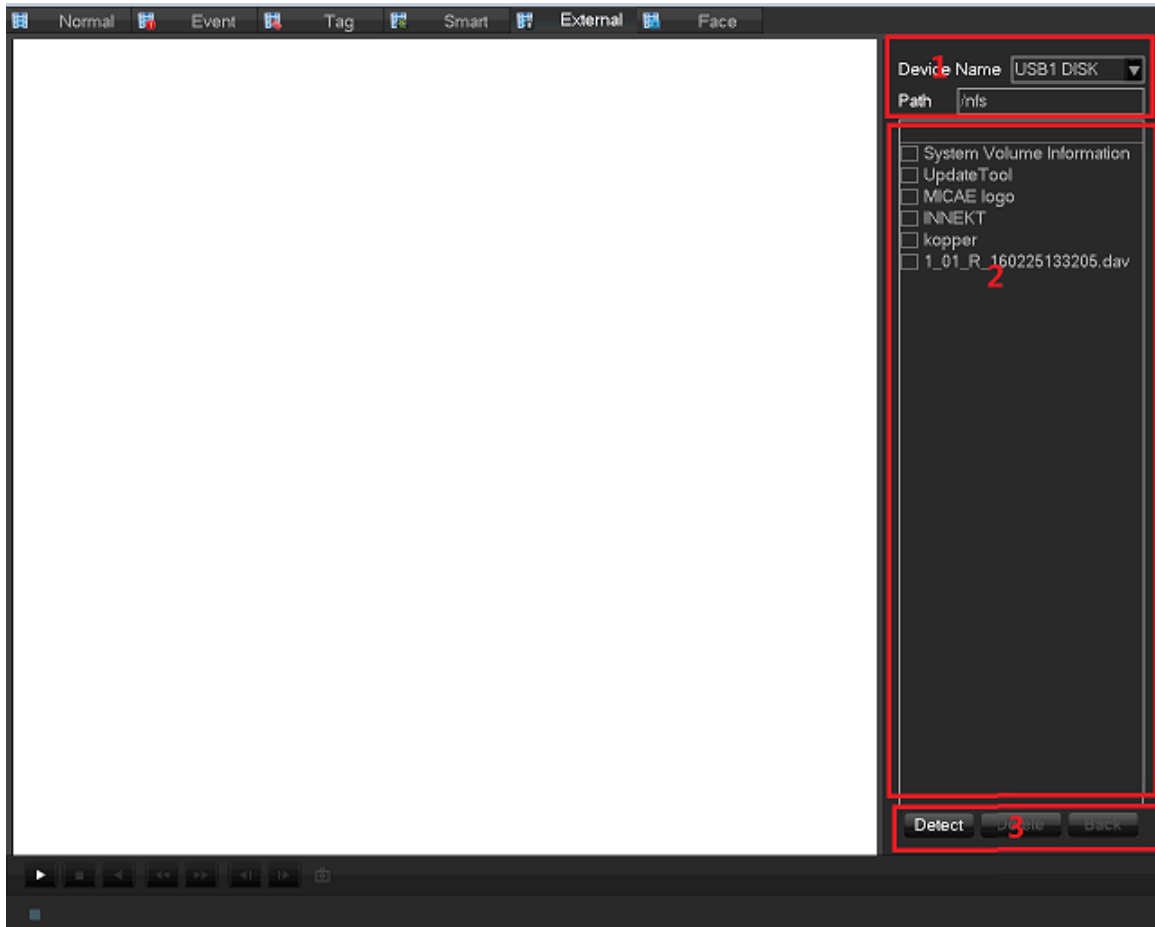

Index	Type	Description
1	File Path	Playback of each channel's of synchronization.
2	Folder Contents	Select channels desired to query records.
3	File Control	[Device Detect] Left-click the device detects the detection insert U disk
		[Delete] Left click, delete the file
		[Back] Click the left mouse button to return to the previous folder

6.7.6 Face search

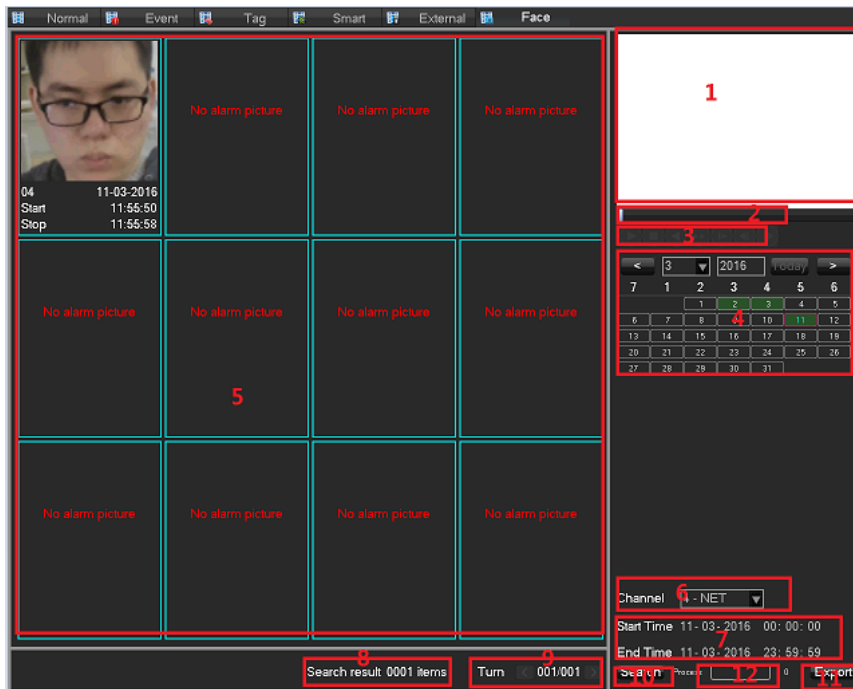

Index	Type	Description
1	Play windows	Play the video.
2	Play Timeline	Display the progress bar of the current event
3	Playback control	stopping / playing, pausing, fast playing, slow playing and the previous/next frame on a suspended state.
4	Calendar	Select the date to search records.
5	Face list	Show the all face images of the channel in the query time.
6	Channel number	Select the channel number.
7	Choose the time	Search the records based on the starting time and end time.
8	Face Statistic	Display the total number of face images and pages of the channel in the query time .
9	Page number	Display the current page and the total number of pages. Page up and page down.
10	Search	Click to search.
11	Export	Export all the face images of the current page..
12	Process	The process of backup

6.8 Record Backup

Interface description

Connect an External USB device with the USB port to backup in the “Record Backup” menu.

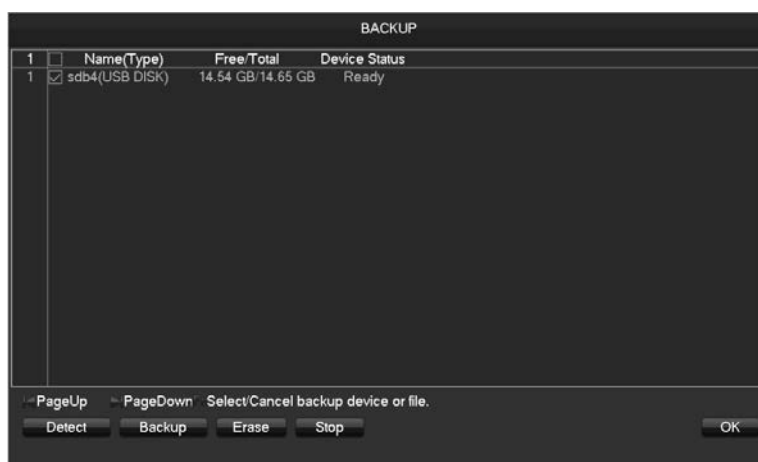

[Detect]Identify external USB device and display the device information.

[Backup]Tick the external device and click**[Backup]**to enter the backup menu .

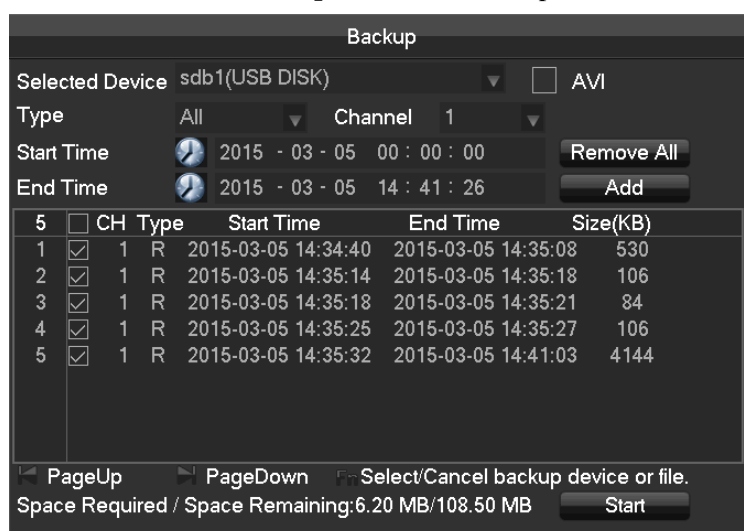

[Cancel]delete all data in USB backup device

Backup Operations

Connect an External USB device with the USB port, click**[Detect]**to Identify external USB device, click**[Backup]**to enter the backup menu ,select the record start -stop time and click to add files in list, click**[Start]**to backup and display time remaining.

⚠Note: USB backup carry player automatically.

This operation probably cause permanent data loss.

7 local Configuration

7.1 The Introduction of the Main Menu

The main menu is shown as the following interface:

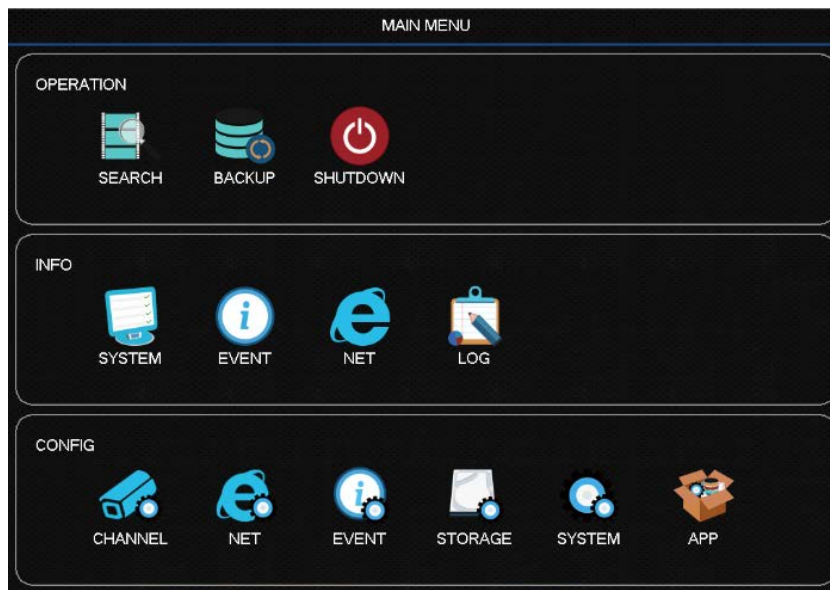

Operation

[Search] based on time, time, label, query and playback video files.

[Backup] backup device detection and video data backup.

[ShutDown] User logs off the device, the device shut down and reboot the system.

INFO

[System] displays the system status, hard drive status, version information.

[Event] displays alarm information.

[Net] stream state, the online user information.

[Log] system log information.

Config

[Channel] Add / Remove the camera, the camera parameters, the basic parameters of the channel configuration, channel mode switch, channel events and joint management parameters.

[Network] basic network configuration parameters settings, manage network interfaces, configure advanced network services.

[Event] External alarm events and abnormal events of the configuration parameters of the device and joint management.

[Storage] Hard disk storage configuration management, video parameter settings, set the record schedule.

[System] Configuration System parameters time, date, language configuration, management and video output parameters polling settings.

[Application Center]E-mail, P2P, cloud storage, mobile phones and other common functions push settings.

7.2 INFO

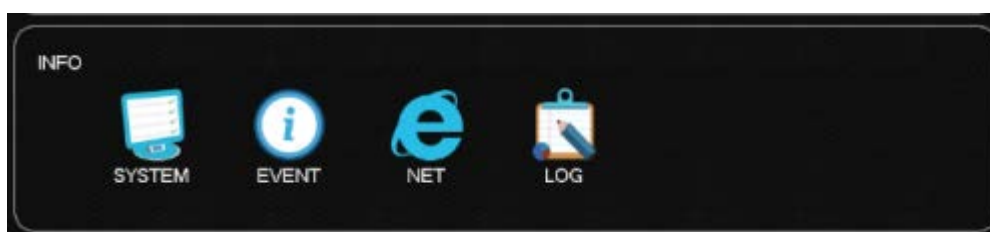

7.2.1 [System]:

It displays the current total capacity of DVR hard disk, the remaining capacity and working conditions. As shown below:

HDD Manage



Record Time

Show starting and ending time of the computer's hard disk recording. As shown below

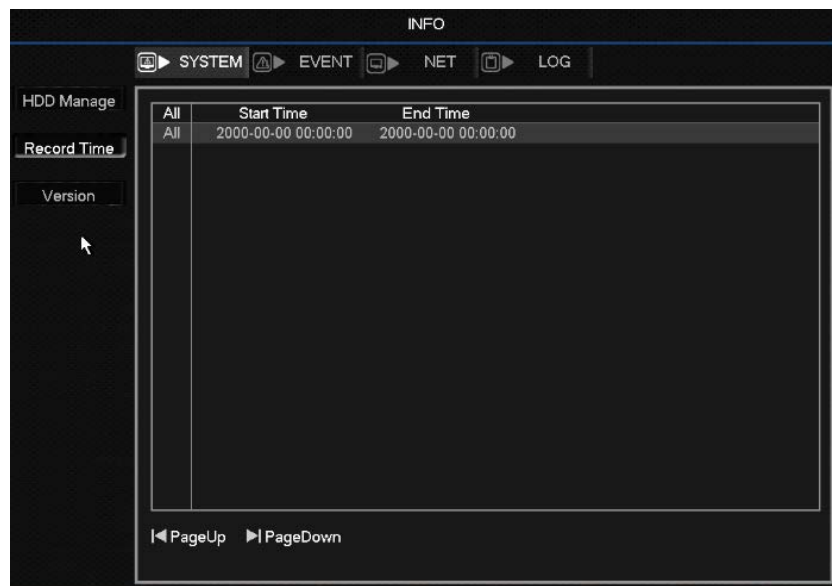

Version

The display device serial number, system hardware features, software version and release date information. As shown below

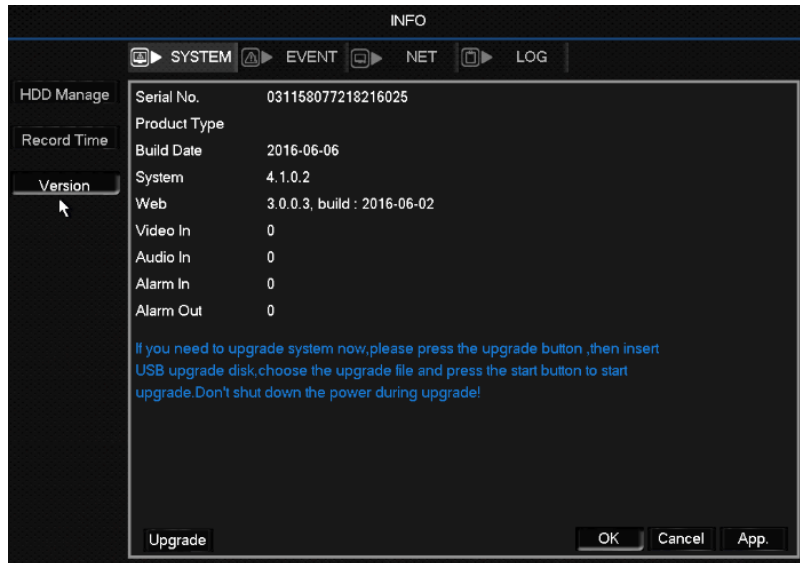

7.2.2 Event

Displays the current alarm status



7.2.3 Net Channel

The equipment with input function use network channel management page for add or delete the equipment and set the front-end configuration.

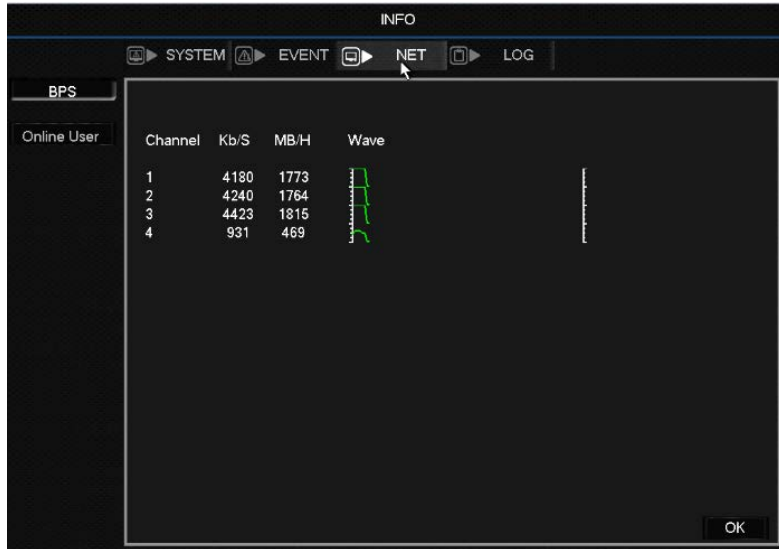

[BPS] show the bitrate and waveform for each channel

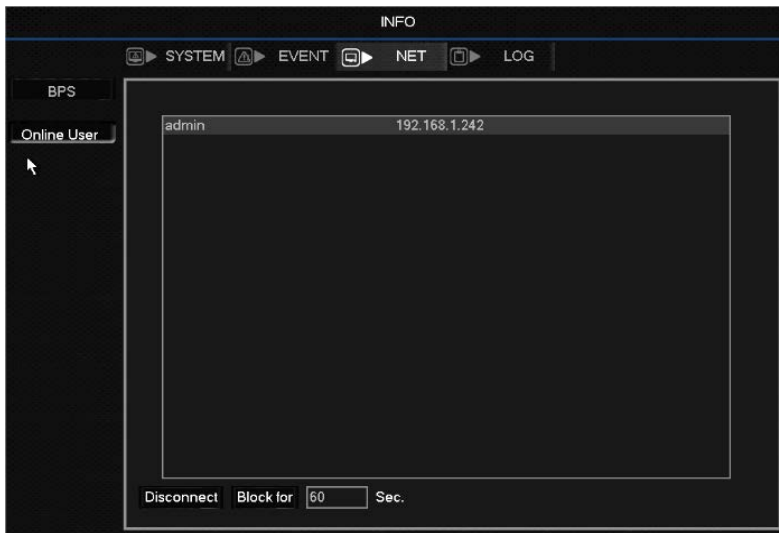

[Online User]View the current online user status, disconnect and shielding

7.2.4 LOG

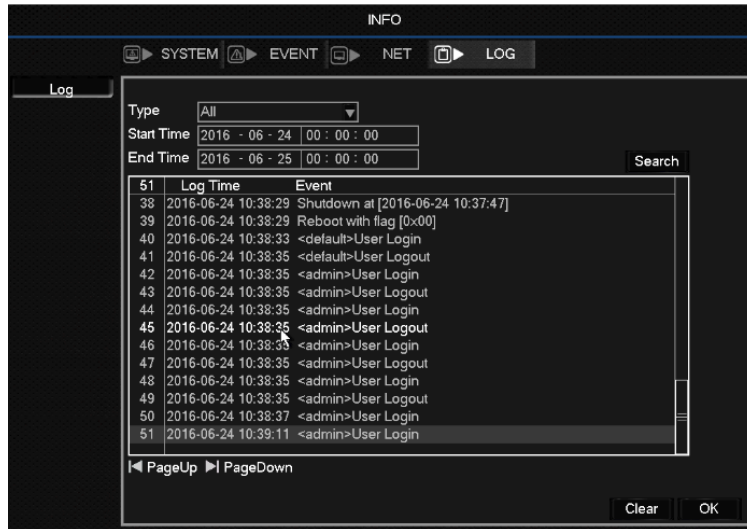

Log information can be divided into system operation, configuration operation, data management, alarm event, recording operation, user management, log clear, file operations.

Select the type and time of the query, press the Find button, the system displays the log as a list, and click the Backup button will log export backup to your computer.

Click the Clear button, the system will remove all types of log files.

7.3 CONFIG

7.3.1 Channel Setting

Base

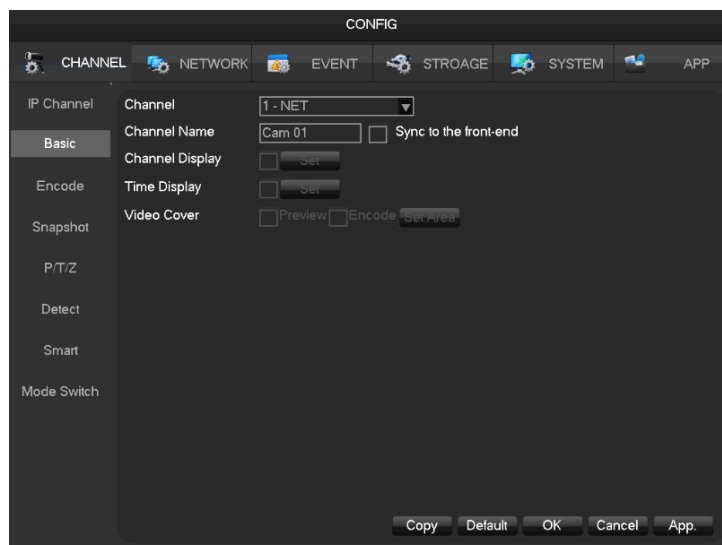

[Channel]to choose the channel no. which needs setting;

[**Channel Name**]to set the channel name if in need;

[**Channel Display**]to set the channel name's display place on the picture;

[**Time Display**]to set the time's display place on the picture;

[**Time Synchronization**]to synchronize the time with net channel and device;

[**Video Cover**]to set some special area which needs special protection while preview and recording.

Encode



[**Channel**]to choose which channel to set;

[**Compression**]H.264

[**Resolution**]there are multiple resolution to choose for main stream. Sub steam too. Users can set the parameter according to their needs.

[**Frame Rate**]PAL: 1fps-25fps; NTSC: 1fps-30fps.



Note: main stream, sub stream and frame rate are vary depending on devices and firmware version.

[**Bit Rate Control**]It includes fixed stream and variable stream. Under fixed stream, user can set encode stream, while under variable stream, user can choose 6 class of image quality, lowest, lower, low, middle level, higher, highest.

Snapshot



[**Channel**]Select a channel.

[**Mode**]Trigger: Crawl images when alarm. Click to enable the function.

[**Image size**]choose different resolution for snapshot.

[**Image Quality**]There are 6 levels of quality.

[**Snapshot frequency**]set highest capture rate for single channel, 1/2/3/4/5/6/7/8 s/pc.

7.3.2 Storage

HDD Manage

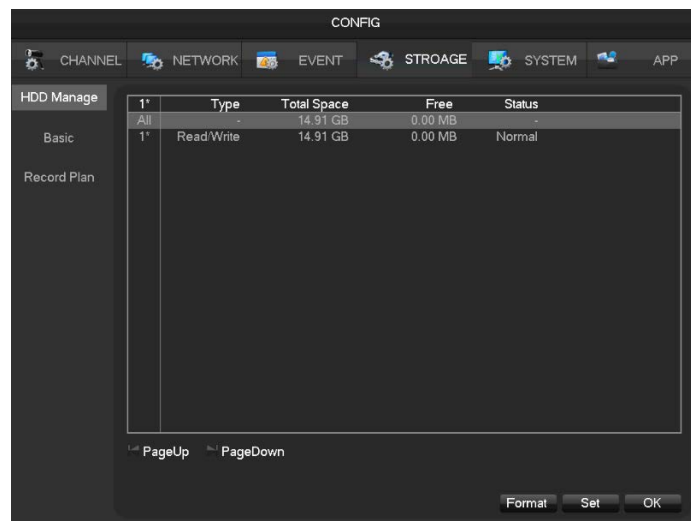

Base

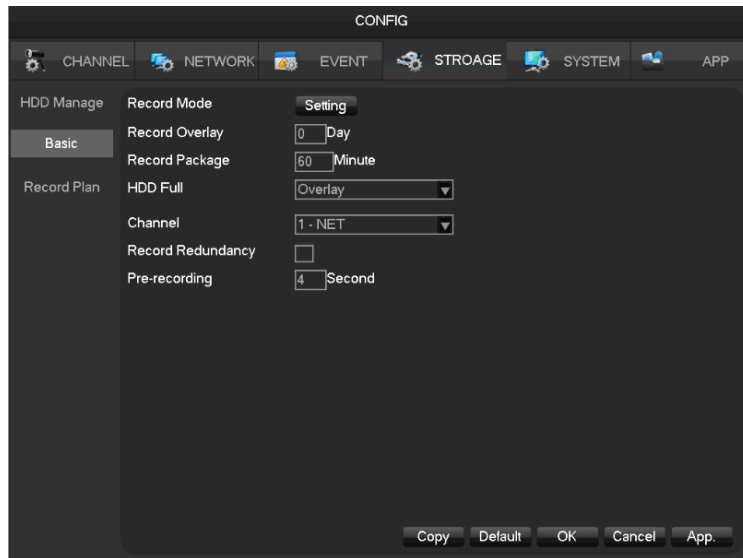

[Video mode]Record automatically, manually or not record.

[Video expiration time]The figure is between 0 to 365.

[Video package time]The figure is between 5 to 120 minutes.

[HDD full]Overwrite or stop recording.

[Channel]Select a channel.

[Video redundancy]Open or close the redundant recording.

[Prerecorded]The figure is between 0 to 30 seconds.

Recording plan

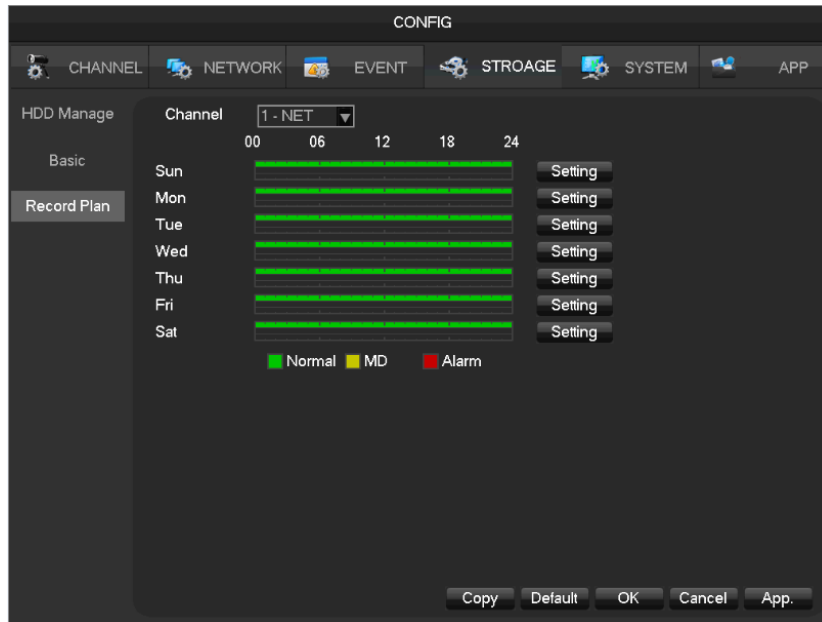

[Channel]select a channel. Green shows normal recording, Yellow shows motion detection, and Red shows Alarm. Users can set or change setting according to date. **[Copy]** copy the setting to other channels.

Click **[Set]** and enter into plan editing picture

Record Type	Normal	MD	Alarm
Period 1 00 : 00 - 24 : 00	<input checked="" type="checkbox"/>	<input type="checkbox"/>	<input type="checkbox"/>
Period 2 00 : 00 - 24 : 00	<input type="checkbox"/>	<input type="checkbox"/>	<input type="checkbox"/>
Period 3 00 : 00 - 24 : 00	<input type="checkbox"/>	<input type="checkbox"/>	<input type="checkbox"/>
Period 4 00 : 00 - 24 : 00	<input type="checkbox"/>	<input type="checkbox"/>	<input type="checkbox"/>
Period 5 00 : 00 - 24 : 00	<input type="checkbox"/>	<input type="checkbox"/>	<input type="checkbox"/>
Period 6 00 : 00 - 24 : 00	<input type="checkbox"/>	<input type="checkbox"/>	<input type="checkbox"/>

Select All
 Sun Mon Tue Wed
 Thu Fri Sat

OK Cancel App.

[Period]set the recording period, there will be 6 period to choose;

[Regular]regular recording

[MD]motion detection recording

[Alarm]alarm recording

7.3.3 PTZ setting

User can set PTZ channel, protocol, address, baudrate etc. Please make sure the PTZ address and connection is correct between PTZ's A, B wire and recorder's A, B wire.

CONFIG

CHANNEL NETWORK EVENT STORAGE SYSTEM APP

IP Channel Channel 1 - NET

Protocol Net Protocol

Basic Address 1

Encode Baudrate 9600

Snapshot Data Bits 8

Stop Bits 1

P/T/Z Parity None

Detect DVR control

Smart Frequency 5 sec.

Mode Switch

Copy Default OK Cancel App.

[Channel]select a channel with PTZ camera

[Protocol]select PTZ camera's PTZ protocol(such as: PELCOD)

[Address]set address, the default is 1

( Note: this address must be the same with PTZ, otherwise the PTZ can not be controlled)

[Baudrate]Select the baud rate. Default is 9600.

[Data Bits]default: 8

[Stop Bits]default: 1

[Parity]default: None

[DVR control]click to enable

[Frequency]default: 3seconds, users can set any digits between 1~30 seconds

7.3.4 Alarm

The traditional alarm events, include video detection (motion detection、video loss、Video shade) and external alarms.

Refer to 6.4.1 Alarm configuration

7.3.5 Channel Mode Switch

Set the channel type (local channel, network channel) and intelligent mode (face detection, perimeter).

Refer to 6.3.1 Channel Mode Switch and 6.4.3 Smart mode Selection

7.4 Backup

Refer to 6.8 Record Backup.

7.5 Application

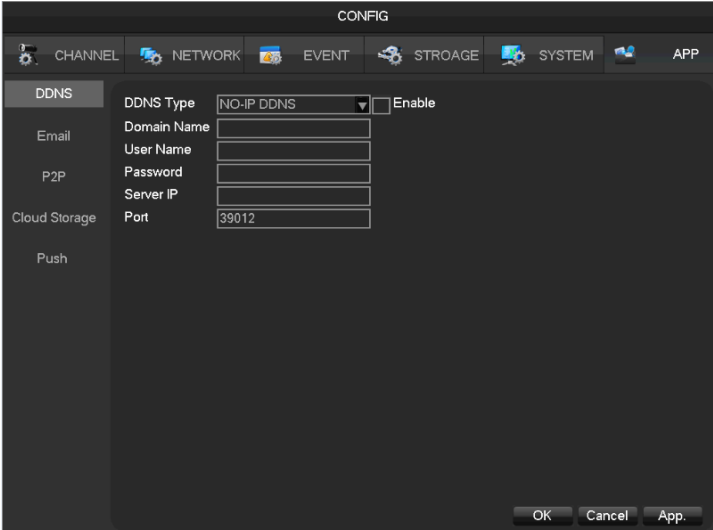

The screenshot shows a web interface for configuring a device. At the top, there is a 'CONFIG' title and a navigation bar with tabs for CHANNEL, NETWORK, EVENT, STORAGE, SYSTEM, and APP. The 'SYSTEM' tab is selected, and the 'DDNS' sub-tab is active. The configuration fields are as follows:

Category	Field	Value
DDNS	DDNS Type	NO-IP DDNS
	Enable	<input type="checkbox"/>
Email	Domain Name	
	User Name	
	Password	
P2P	Server IP	
	Port	39012
Cloud Storage	Port	39012
Push		

At the bottom right of the configuration area, there are three buttons: 'OK', 'Cancel', and 'App.'.

[DDNS] check the device setting through domain name

[Email]set the sender's email SMTP server IP address, port, username, password and sender's mail box, mail SSL encryption.

[P2P] setting of P2P transmission

[Cloud] bind with cloud storage service and set synchronization rule.

7.5.1 DDNS

Summary

Dynamic DNS is a kind of system which point internet domain name to variable IP. According to the rule of internet domain name, domain name must associate with the fixed IP address. Dynamic DNS provide a fixed Name server for the dynamic domain, and then guide the domain search to the IP address of dynamic user through Name server, which can make the outside user connect to the dynamic user's URL.

FNT DDNS

FNT DDNS is built-in professional dynamic DNS service in our network DVR. You can register directly in the device .Specific steps are as following.

[Main menu]-[Network]-[Application]-[DDNS], choose FNT DDNS

- 1: Select FNT DDNS and Enabled it.
 - 2: Input one user name, there will be a domain name generated auto. Domain name = user name.faceaip.net.
 - 3: Input the password
 - 4: Click “Register” button. If the domain name is not registered, it will pop up a message that connect DDNS server successfully otherwise it will prompt that the registration is failed.
- Suggestion: you'd best change the DNS server in basic configuration to the router's DNS server
- 5: Click the “ok” button to complete the settings.

No-ip DDNS

Register

Register new account at www.no-ip.com

Embedded DVR/NVR Setting

Open [Main Menu]-[APP Centre]-[DDNS], choose NO-IP DDNS.

Refer to the following configuration:

Name	Configuration
DDNS type	NO-IP DDNS
Host IP	dynupdate.no-ip.com
port	80
Domain name	xxx.xxx.org (xxx: domain name)

	created)
User name	xxx (user name registered)
password	xxxxxx (password registered)

Dyndns DDNS

Register

Register new account at www.dyndns.com

Embedded DVR/NVR Setting

Open [Main Menu]-[APP Centre]-[DDNS], choose NO-IP DDNS.

Refer to the following configuration:

Name	Configuration
DDNS type	Dyndns DDNS
Host IP	Members.dyndns.org
port	80
Domain name	xxx.xxx.com (xxx: domain name created)
User name	xxx (user name registered)
password	xxxxxx (password registered)

7.5.2 Email

Refer to 9.1.8 Send Email.

7.5.3 P2P

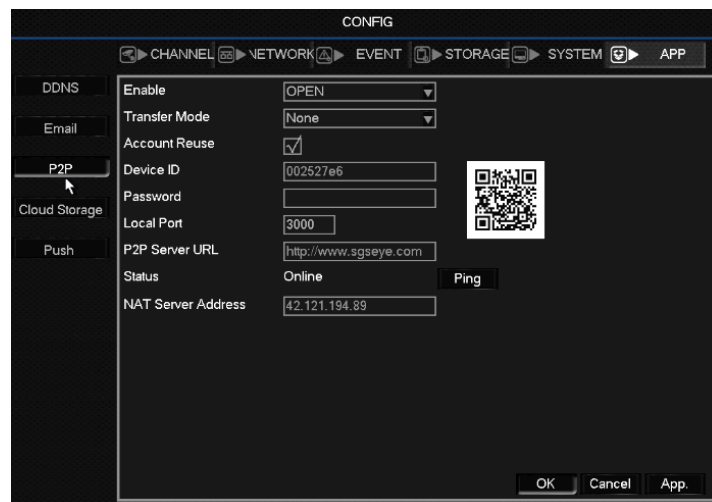

[Enable]Open/Close P2P function

[Transfer Mode]Network transfer strategy, choose Quality priority or Fluency priority

[Account Reuse]enable it supports multiple users log in the same device

[Device ID]display device ID

[Password]device password

[Local Port]set local port

[P2P Server URL]P2P server URL

[State]current connection state

7.5.4 Cloud storage

Refer to 9.1.10 Send NetDisk.

7.5.5 PUSH

Refer to 9.1.8 Push server

7.6 System setting

7.6.1 Basic setting

Get into the [Bacical] menu under [Configuration]

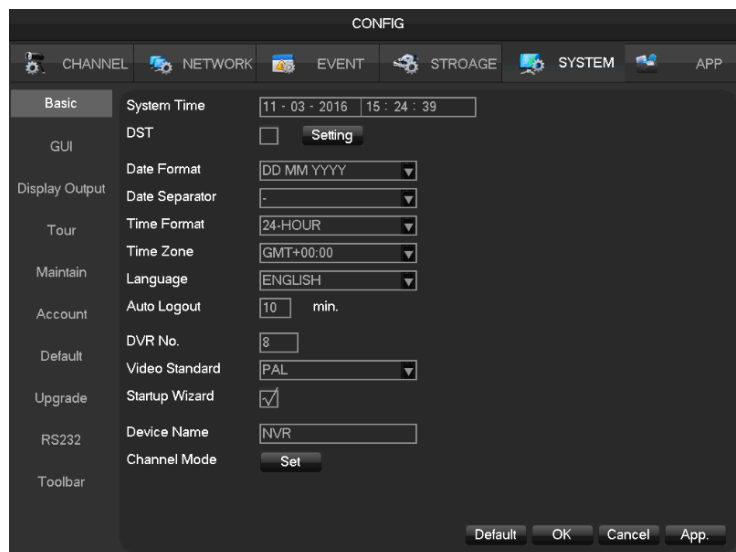

[System Time] set the HD record system time



Note: please click the "save" button to save the time after setting

[Daylight Saving Time (DST)] Enable the function and click "Set" to enter the local DST starting and ending time setting.

[Date Format] Modify the date display format

[Date Separator] Select the separator for date

[Time Format] 24 hr or 12 hr display mode

[Time Zone] Select the time zone

[Language] Select language (different models have different language choice)

[Auto Logout] set menu stand-by time from 0-60 min. 0 min means no standby; if set a time, system will logout

auto after this period time and user need to login again.

[DVR No.]Used for a remote control or keyboard control multiple devices. Please click “Ad” button on remote control and input the corresponding DVR number to operate.

[Video Standard]PAL/NTSC (must keep the same with the front-end camera)

[Startup Wizard] enable switch, open/close the startup wizard interface

[Device Name] used together with the push, display this device name in the alarm message received in iPhone.

[Channel mode]The selection of local channels and network channels.

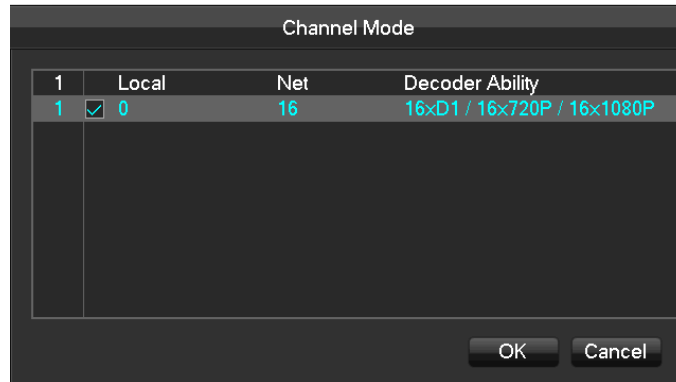

Select hybrid or NVR mode according the menu prompt and save. Reboot the device after channel mode modification. Channel mode introduces the device recording ability under different modes. Real recording ability needs refer to the detailed device specification.

7.6.2 Video output

GUI Display

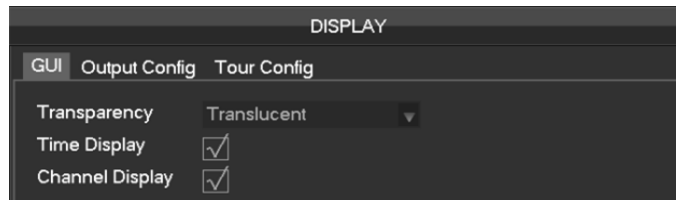

[Menu Transparency] adjust menu transparency , four degrees

[time display] enable switch for time displayed in live view

[channel display] enable switch for channel name displayed in live view

Output mode

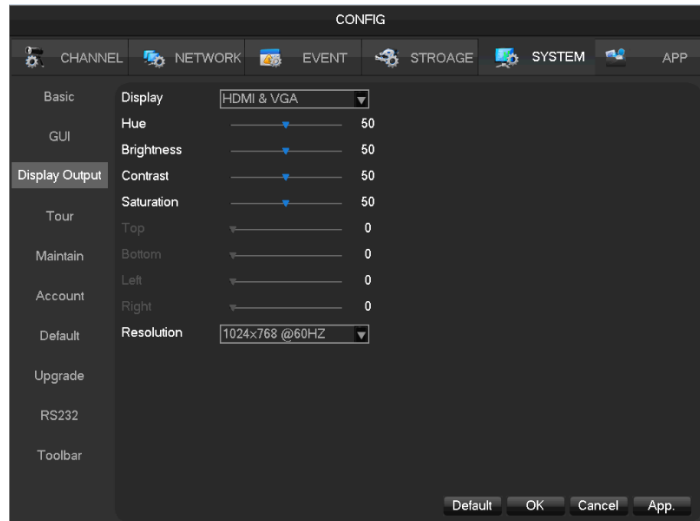

[Display]CVBS/HDMI&VGA

Under CVBS mode, user can adjust the monitor or TV hue, brightness, contrast and saturation. You can also adjust the right TV output area when the displayed image is not full or beyond the scope of the monitor. Under HDMI&VGA mode, user can only adjust the monitor hue, brightness, contrast and saturation.

[Resolution]select the VGA output resolution and refresh rate, total includes 1024×720@60Hz 、 1024×768@60Hz、 1280×1024@60Hz、 1366×768@60Hz and 1920×1080@60Hz five choices.

Tour Configuration

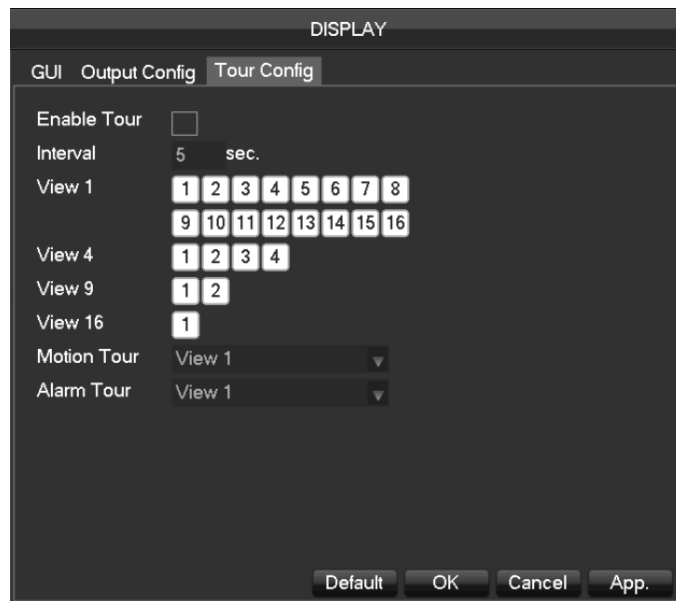

[Enable Tour]Enable switch

[Interval] Ttour interval time is 5-120s

[View]It includes single screen, four-, nine-, sixteen-screen.

[Motion Tour]Set the motion detection tour mode

[Alarm Tour]Set the alarm tour mode

7.6.3 Storage management

HDD management

Show the current HDD capacity, spare capacity and working status in the DVR/NVR

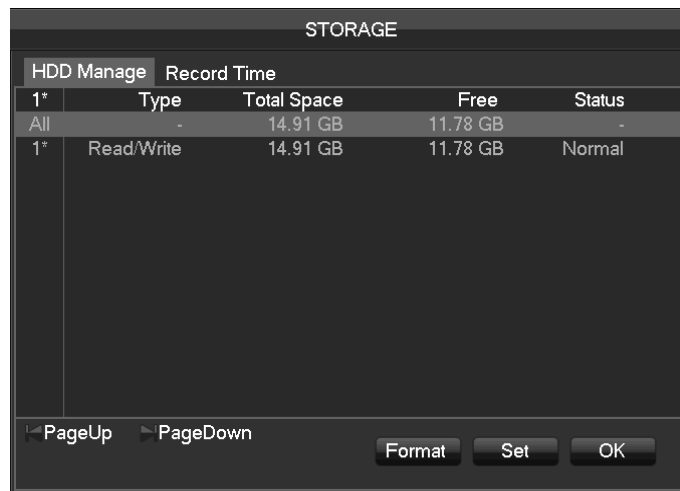

[Format]Format one HDD, user must have appropriate permissions



Note: Hard disk format operation results in the loss of video data

[Set]Set HDD as read-write, read only or redundancy mode. Video data can be protected from covering under read only mode. It supports HDD S.M.A.R.T smart detection at the same time.

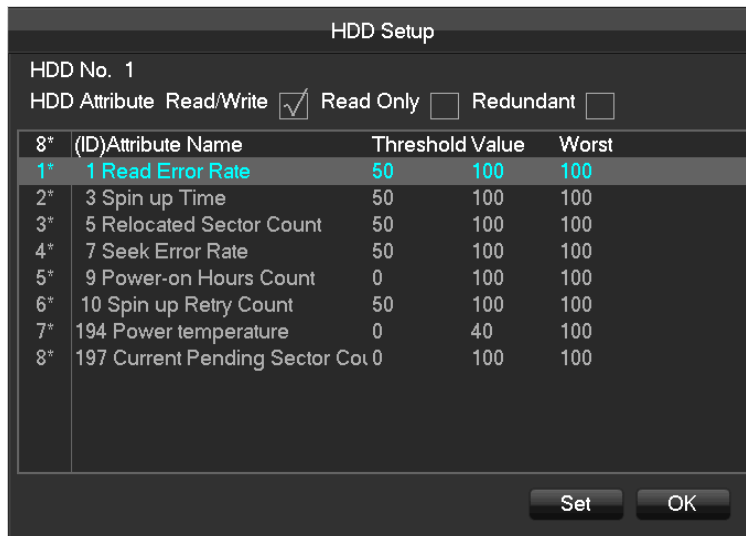

Record time

Show the record starting and ending time in the device HDD

STORAGE		
HDD Manage	Record Time	
	Start Time	End Time
All	2014-03-03 11:31:30	2015-03-05 15:31:05
1*	2014-03-03 11:31:30	2015-03-05 15:19:38
	2015-03-05 15:18:20	2015-03-05 15:31:05

PageUp PageDown OK

7.6.4 ABNORMITY

Refer to 6.4.2 Equipment Abnormal.

7.6.5 System Status

stream statistics

STATUS			
BPS	Online User		
Channel	Kb/S	MB/H	Wave
1	0	0	█
2	0	0	█
3	0	0	█
4	0	0	█
5	0	0	█
6	0	0	█
7	0	0	█
8	0	0	█

Back Next

[stream statistics] Provide capacity size of video files for reference, stream statistics for each channel, waveform display.



Noted: This statistic is an estimate only for reference

Online user

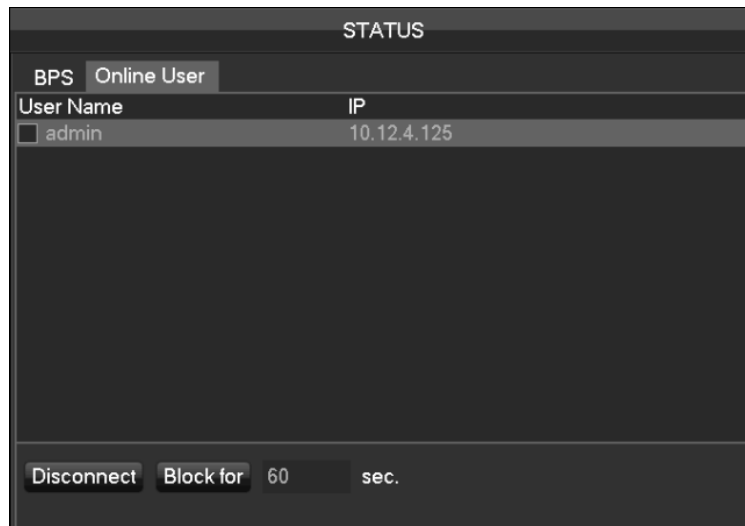

[Online user]Online users can view the current status, disconnect and shielding.

7.6.6 Maintain

System Logs: Display system logs, convenient for users to check.

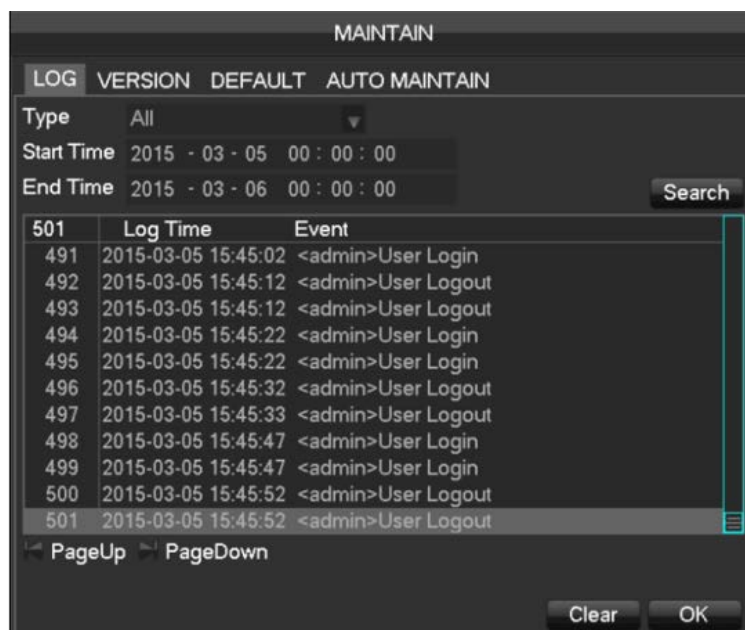

Log information can be divided into system operation, configuration operation, data management, alarm event, record operation, user management, log clear, file operations.

Select the type and time of the query, press the Find button, the system displays the log records in a list, and click the Backup button export backup logging onto your computer.

Click the Clear button, the system will remove all types of log files.

Version

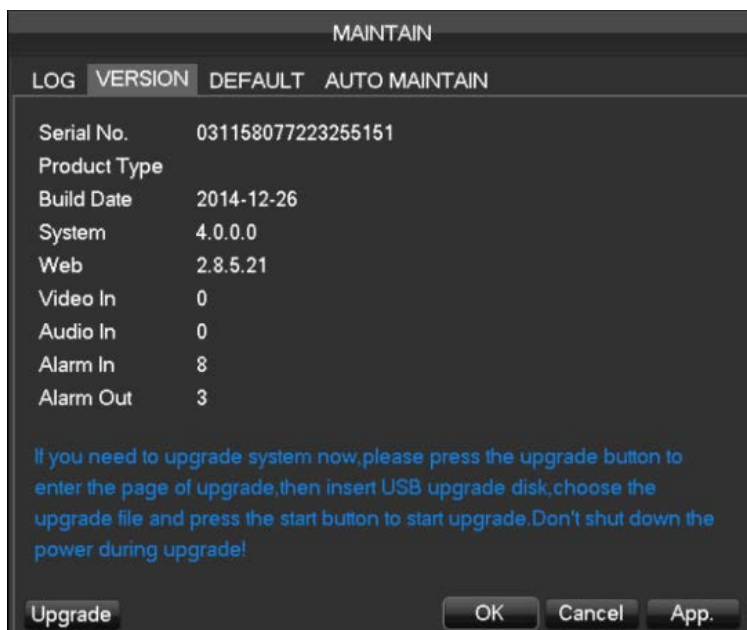

[Version] Display device serial number, system hardware features, software version and release date information.

[Upgrade] System software can be upgraded: Insert a USB storage device, click Upgrade.



Noted: System upgrade may cause the DVR can not start properly, please Operation under the guidance of the company's technical staff.

Default

[Default] System back to the default configuration factory state (specific items recovered optional)

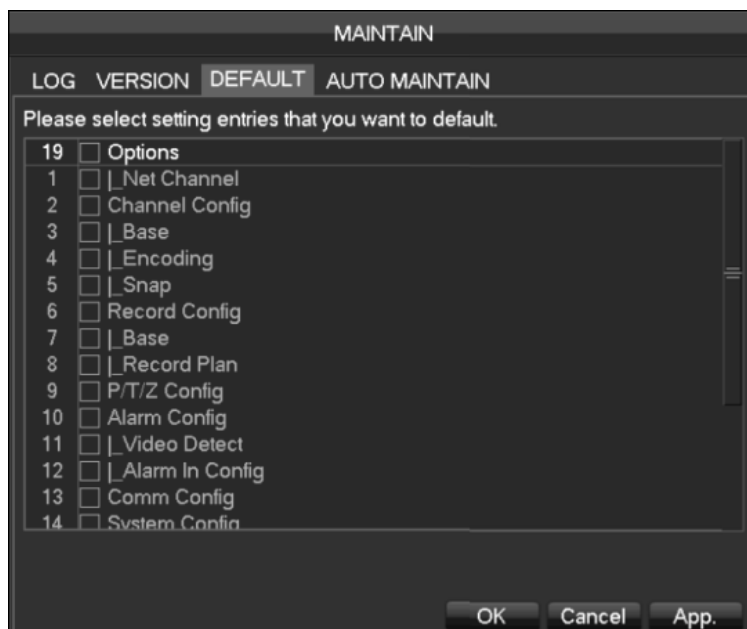

Noted: Menu color, language, time and date format, video format, IP address, user accounts and so on will not be restored.

Auto Maintain

[Auto maintain]Set the desired the project of automatic maintenance.

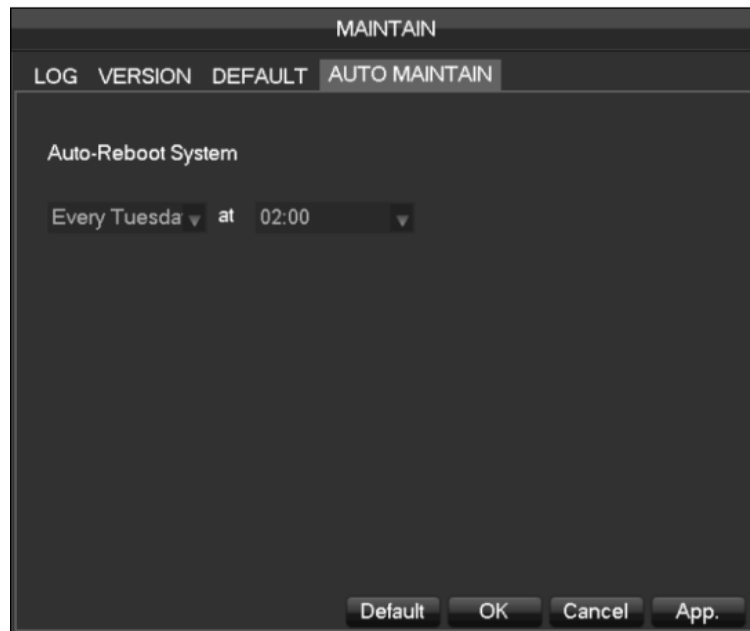

7.6.7 Account

Basic Considerations of User Management:

- The following user names and user group names, etc., character and length consisting up to six bytes, the invalid string is trailing spaces. Legal characters: letters, numbers, underscores, minus sign, point, other characters are not allowed to use .
- the number of users and groups is not limited, User Group increased or delete according to user-defined: The factory settings are user \ admin two groups. Users can set their own related group, the group of users can be freely re-assign permissions at the group permissions.
- user management using two methods of user and group, , Group name and the user name cannot be repeated, , each user must belong to a group, a user can belong to only one group.
- There are three users: admin, user, and hidden default initialization. The factory password for first two are 123456. admin default user permissions are high at the factory, and the factory default user as a low privileged user, only for monitoring, playback.
- hidden default: This user system for internal use and cannot be deleted. When local is in "no user is logged" state, the system will automatically log in with this account. Users can modify this account permission to do what free login can do.
 - Enter to the menu interface of increase user, Enter your user name and password, select belongs to which group, and select whether to reuse this user. Reuse means that the account can be used simultaneously, multiple clients can use the account. .

Once the group belongs selected, the user's permissions only a subset of the group, not ultra vires the properties of the group.

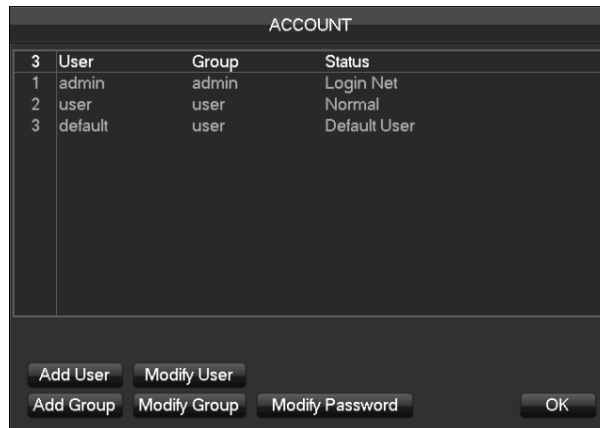

[Add User]Increases users within the group and settings user access control.

[Modify User]Modify the user and settings user access control.

[Add Group]Add group and settings group access control

Enter into the menu interface of Increase the group, determine the group name, select 83 access control, left click mouse button to confirm, save the new user group.

[Modify Group]To modify the group attribute which already exists.

[Modify Password]To modify the password of user account.

Select the user, enter old password then enter new password and confirm

Click[confirm]button to make sure modify password.

The password can be set 1-6. Beginning and ending spaces is invalid password, you can have a space in the middle.

Users which has User Account Control permission can change their own passwords, can also modify other users' passwords.

7.6.8 Network

Network configuration interface can set the DVR network parameters. DVR factory default IP address is 192.168.1.88. The menu contains the network settings of basic setup, advanced settings and network service application settings.

Basical

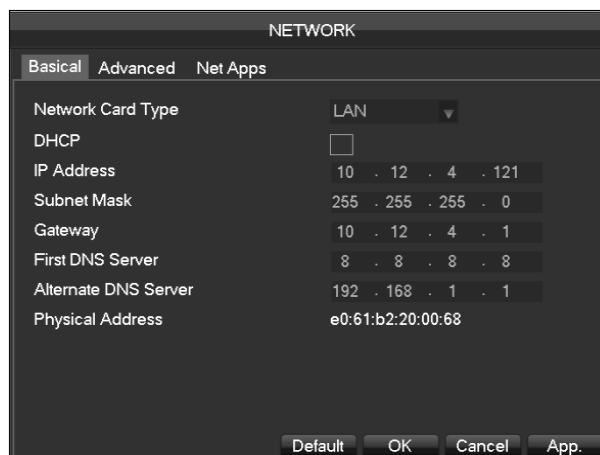

[Network Card Type]LAN 1、 2 can be selected by Dual LAN equipment

[DHCP]Automatic search IP function. When you open the DHCP IP / Mask / Gateway cannot be located, if the

current DHCP in effect, the IP / Mask / Gateway DHCP display values obtained can be found in the network state [IP Address]Use (▲▼) or input numbers to modify IP, then set [subnet mask] and [default gateway]for this IP.

[First DNS Server]DNS server IP

[Alternate DNS Server]DNS alternate IP

[Physical Address]physical address of current net port

Advanced

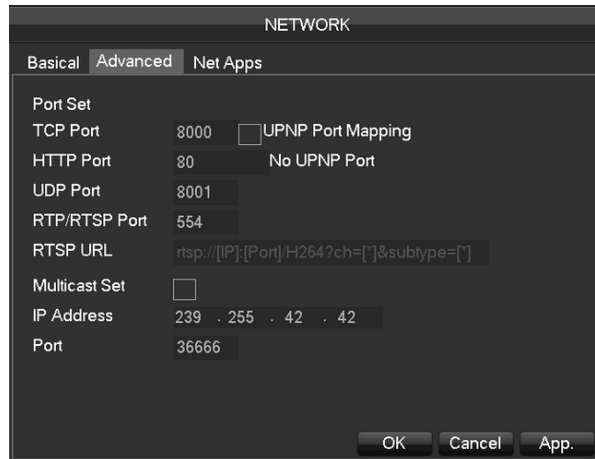

[TCP port]8000 as default, Can set the port according to the actual needs of the user.。

[HTTP port]80 as default.

[UDP port]8001 as default, Can set the port according to the actual needs of the user.。。

[RTP/RPSP port]554 as default.

[UPnP]Protocol can turned on port mapping by the router automatically, when using this feature, make sure UPnP is enabled on the router function.。

[Multicast]Multicast IP address range restrictions in the following figure, the multicast port number is not restricted.。

Network

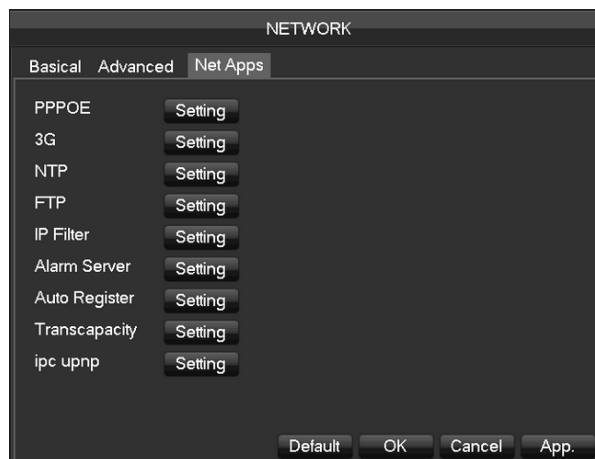

[PPPOE]Select Enable switch to turn on the PPPOE dial-up service of the device.。

Enter ISP (Internet service provider) provide the saving of user, password for PPPoE

Operation: Succeed after dialing, check the [Network Status]IP, then enter the IP address to access the device after open IE.。

[3G]Support 3G card dial-up to provide remote access device features.。

[NTP]Select Enable switch to turn on the NTP protocol support, can be with SNTP communication server to realize automatic calibration function.。

Host IP: Enter the IP of NTP service NTP

Port: Supports TCP transport only, port is limited only 123。

Update cycle: interval time is 1 minute or more, the maximum update period is set to 65,535 minutes。

Time zone: London GMT+0 Berlin GMT +1 Cairo GMT +2 Moscow GMT +3 New Delhi GMT +5
Bangkok GMT +7 Hong Kong&Beijing GMT +8 Tokyo GMT +9 Sydney GMT +10 Hawaii GMT-10
Alaska GMT-9 Pacific Time GMT-8 US Mountain Time GMT-7 US Central Time GMT-6 US East Time
GMT-5 Atlantic Time GMT-4 Brazil GMT-3 Atlantic – Central GMT-2。

[FTP]Select the Enable box to make the protocol enable, to enter the FTP settings menu。

Two kinds of FTP upload file types are video files and pictures, set up an FTP server address, port, remote directories and so on. When remote directory is empty, the system will automatically create a different folder by IP, time, channel。

User name, password to access the FTP username and password.

Set upload file size, you need to upload the file channel, time, type, etc.

Set upload length which upload to FTP server file length, if less than the set value, the entire video file upload; If more than the set value, upload take part from the beginning and set the value of consistency, the file later omitted; setting a value of 0, then upload the entire video file.

Different channels can be set two different time periods, three types of video recording.

[IP Permissions] for permission to access the DVR IP rights management. When choosing the white list, the list indicates that only the IP to connect this DVR. The list of supported 64 IP settings. If the selected item is not ticked, no restrictions on access to the device's IP.

[Alarm Center] alarm interface for customers to reserve the use of self-development.

[Network transmission capacity]

[Number of network user connections] number of connections: 0-10, if you set 0 means the network does not allow users to connect ; the maximum number of connections is 10.

[Number of network Monitoring connections] the number of connections is recommended: 0-32, this need to tick to start this function. Real-time video over the network for browsing, the number of connections depending on network bandwidth, the number greater , the larger the network load, will impact of video playback fluency.

[Number of ownload Internet connections] the number of connections to download recommendations: 0-8, this need to tick to start this function

[Network transmission QoS] smooth network transmission quality priority or image quality priority or adaptive, depending on the setting, the network adjusts the stream automatically.

7.6.9 RS232

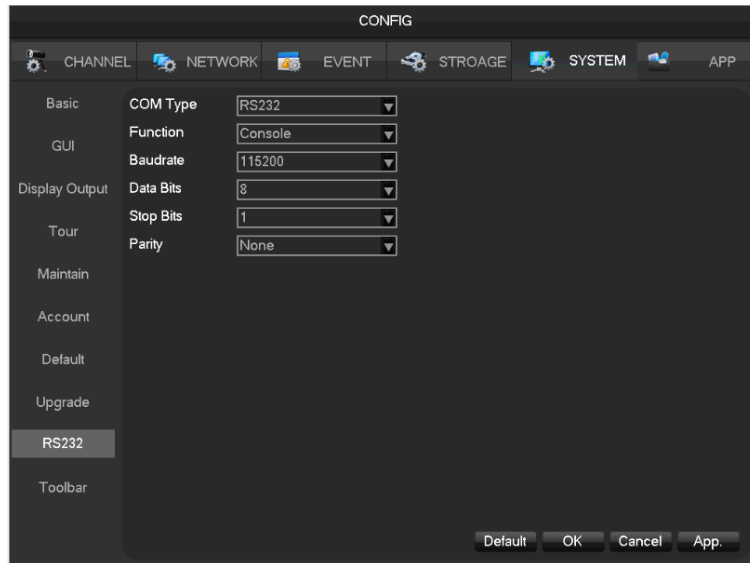

[Function]Select the appropriate serial protocol

[Regular]used to update firmware and adjust

[Keyboard]used specialized keyboard to control the device by serial port

[Transparent serial port] used to transmit serial port data transparently

[Net keyboard]use specialized keyboard to control the device through network

[PTZ] connect with matrix



Note: some models do not have RS-232 serial port, please refer to some relative data sheet.

[Baudrate]select the relative length of baud rate

[Data Bits]default: 8

[Stop Bits]default: 1

[Parity]default: None

8 WEB Access

8.1 WEB Operation

8.1.1 Network Connection

Check whether the DVR is on the network by checking B-Lamp on front panel, light indicates connection, otherwise connection error.

Set IP, subnet mask and gateway for computer and DVR. Please assign the same segment IP address without router, need to set the appropriate subnet mask and gateway with router.

The detail of DVR network configuration please see[**Configuration**]-[**Network Setting**]

Ensure the IP is correct and check whether the DVR is on the network by using the Windows command “ping”.

8.1.2 The control installation and the user login logout

Users can remote access to DVR by Internet Explorer, assuming you have a correct network configuration. The following interface will pop up when you access the IP address in Internet Explorer.

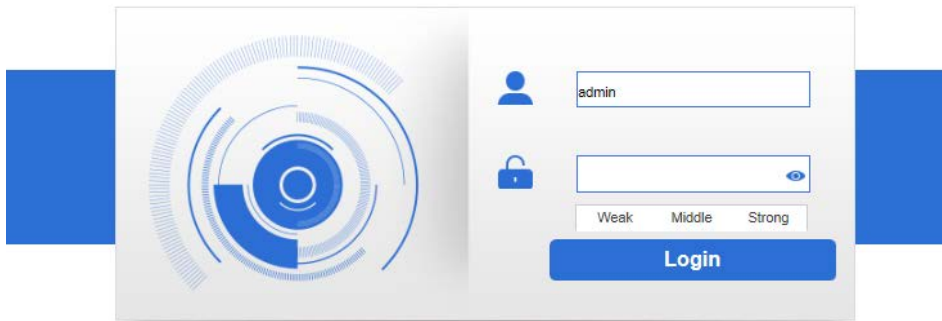

The following interface will pop up when you log in.

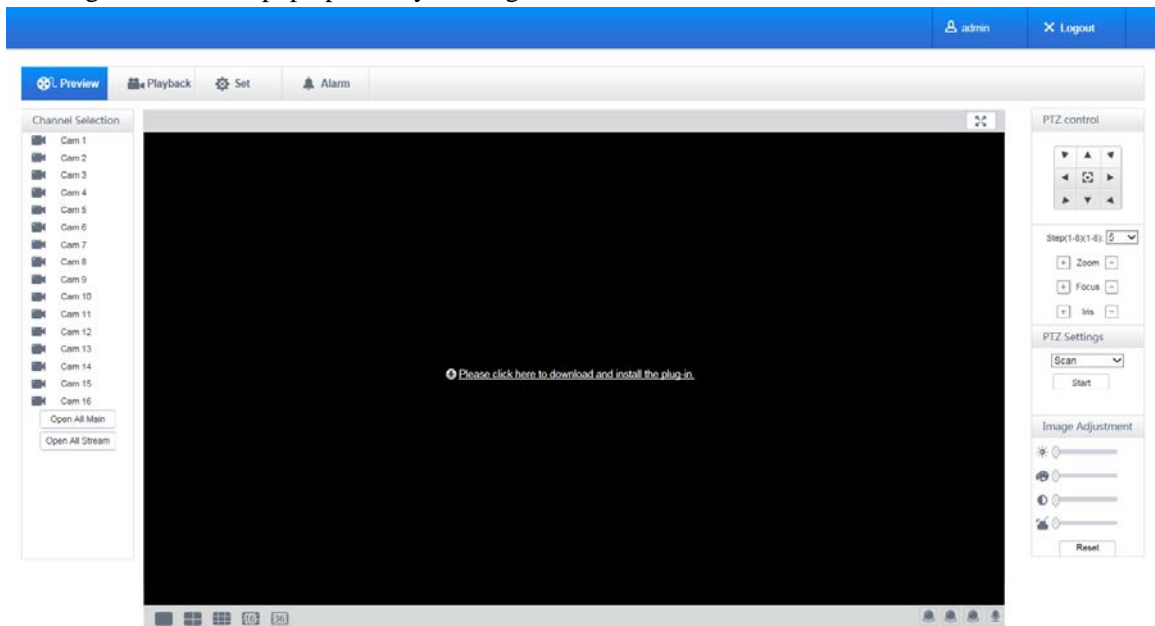

Will be displayed in Compatibility View option is checked on all websites.

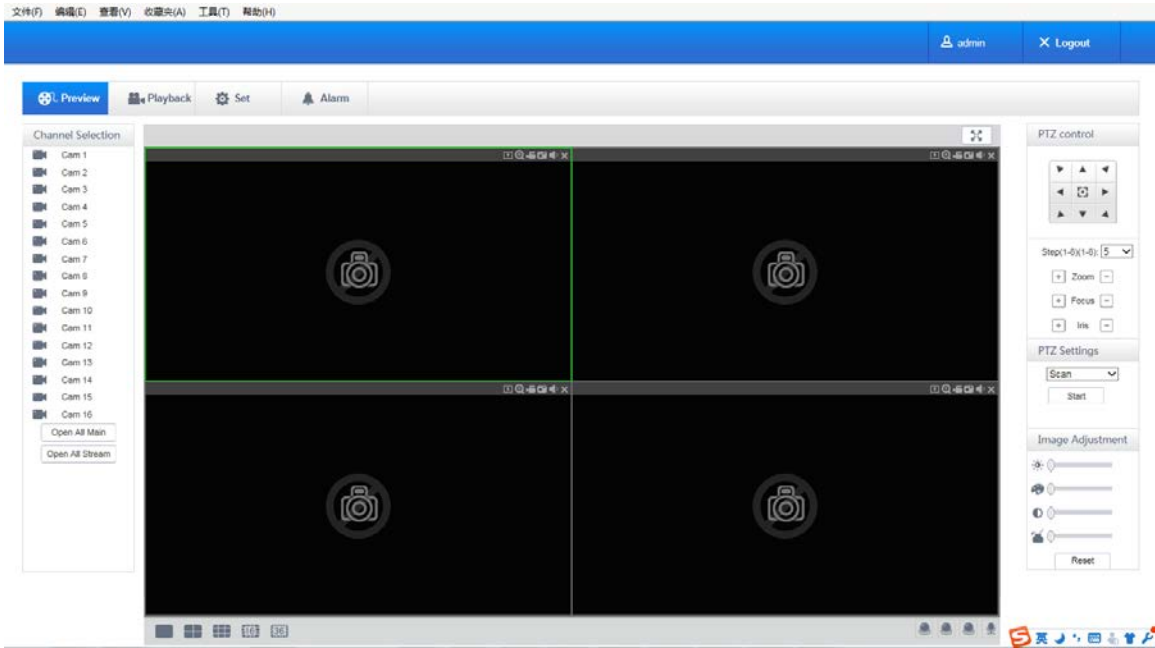

8.1.3 The Interface Of Web Operations

WEB Interface Description

After log in the web, the preview interface will pop as following:

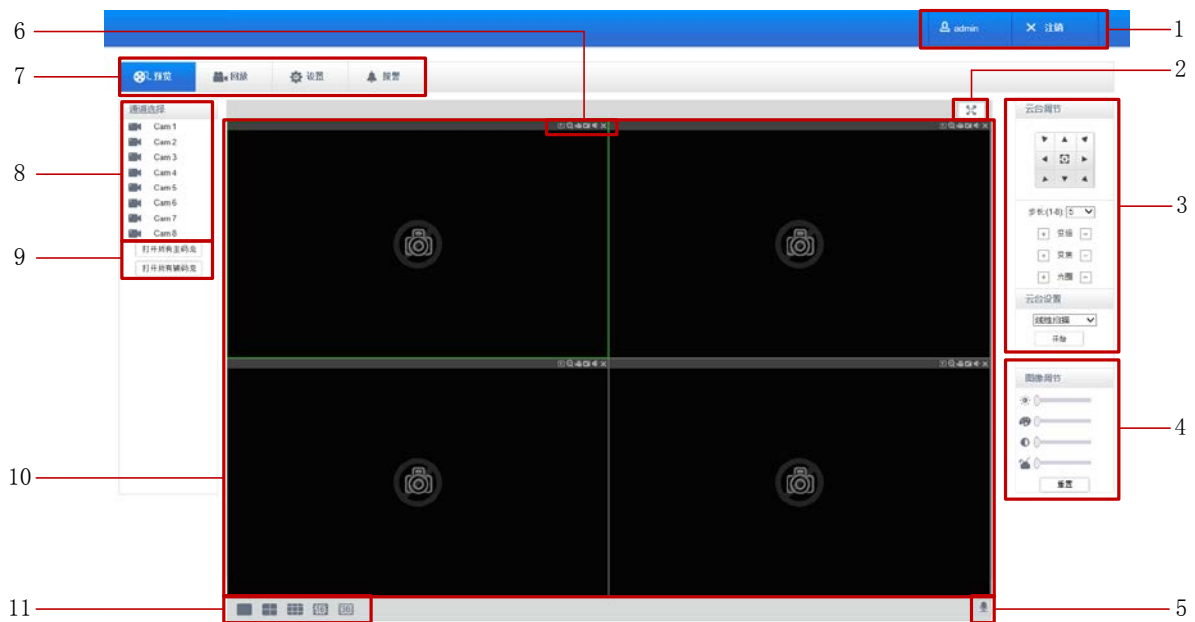

WEB Interface
Description

Index	Name	Description
1	Log out	Show the current login user, click on log out
2	Full Screen	Full screen preview
3	PTZ control	PTZ control menu
4	Image color & other	Image color: modify brightness, contrast and

	saturation	Other: set capture path, record download path and reboot
5	Device function key	Two way talk function key and etc.
6	Channel function key	screenshots, electronic amplification function keys and etc
7	Menu	System configuration, record search, alarm setting, exit, etc.
8	Channel Selection	Realtime channel preview selection
9	All open key	Open all can be open all channels real-time monitoring (main/auxiliary stream) in the video monitoring window
10	Surveillance window	Real time recording or playback
11	Channel segmentation window	Provide the single picture, 9, 4 picture image segmentation method.

Select the focus window

Into the WEB interface, select the focus window in live window, the focus window has a light green border.

Preview Channel Selection

The left channel column is as following picture:

8.1.4 The Real-time Monitoring

Into the WEB interface, select the focus window in live window, the focus window has a light blue border.

From the left channel column select channel, as shown in the following interface.

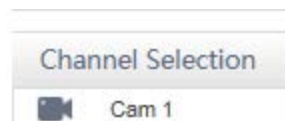

Click on 2 area in upper right corner can choose open / close the channel of the main stream or secondary stream, shows the current DVR's IP and rate information.

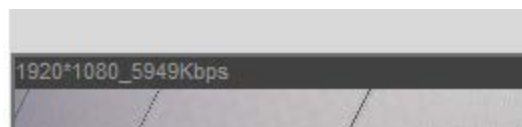

Lower left corner shows the current video channel name.

Upper right corner shows the current video time information.



Click “ ” (Lower left corner of the display window) to switch between single screen and multi-screen.

Lower right corner of the display window is function keys, as the following interface. Refer to area zoom, switching multi screens, local records, capturing and so on.

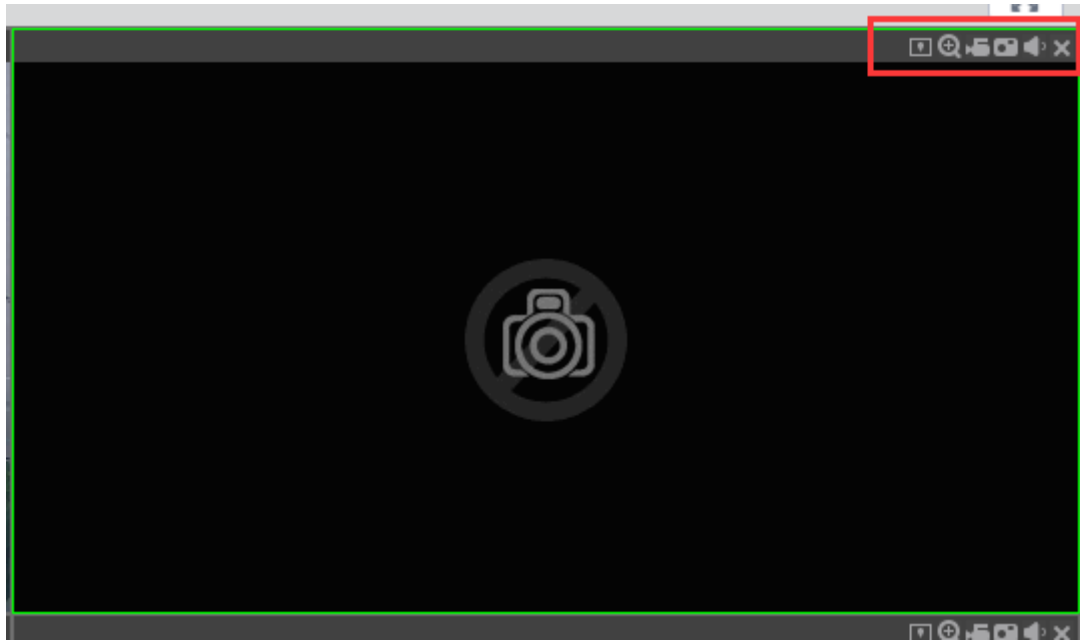

Area zoom: Video images can be enlarged.



Multi-screen switch: switch from single screen to multi-screen and vice versa.



Local record: save and record video to a local HDD while in a live view. Set recording path in configuration.



Capture: capture of the present channel, set the path in "other."



Sound: on/off sound.



Off video: off the focus window video.

8.1.5 PTZ Control

Set protocol (see[**Setting**]-[**PTZ**])

Control PTZ direction, step size, zoom, IRIS, preset, tour, pattern, border scan, light, wiper, auto pan, etc.

Step size controls PTZ direction and speed, e.g. step size 8 is moved faster than step size 1.

Eight direction rotations: up, down, right, left, up-left, up-right, lower left, lower right.

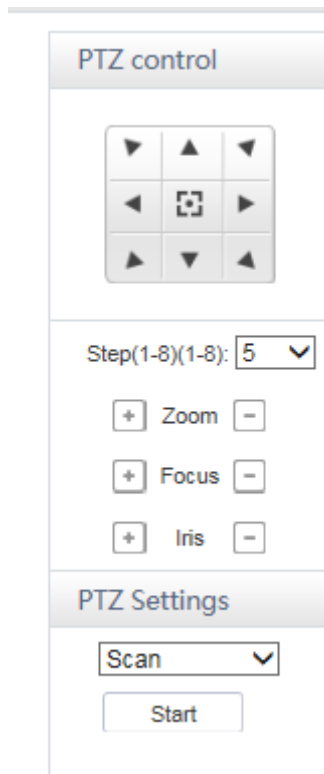

Border scan

Operation: select the camera line scan of the left/right margin by direction button, and click the Settings button in the left /right margin position to determine the left border.

Preset

Operation: modify preset position by direction button and inputting a preset number, then click “Add” to save.

Tour

Operation: select “Tour”; Point between the first cruise line cruise input box value. And input numbers in “Path” and “preset”. Click[**Add Preset**]to add one preset in the cruise path, and repeat to add additional presets. Click [**Clear Preset**]to delete a preset, repeat to delete more.

Pattern

Operation: Click “Pattern” in order to record an automated pattern. Then, go back to the PTZ controls in order to modify the zoom, focus and IRIS, etc. Stop recording in “Pattern” setting to save the pattern.

AUX

On/off one of AUX

Wiper

On/off wiper under protocol

8.1.6 Configuration

Access DVR local configuration menu by click “System Setting”, the further details please refer.

[**Local operation guide**]

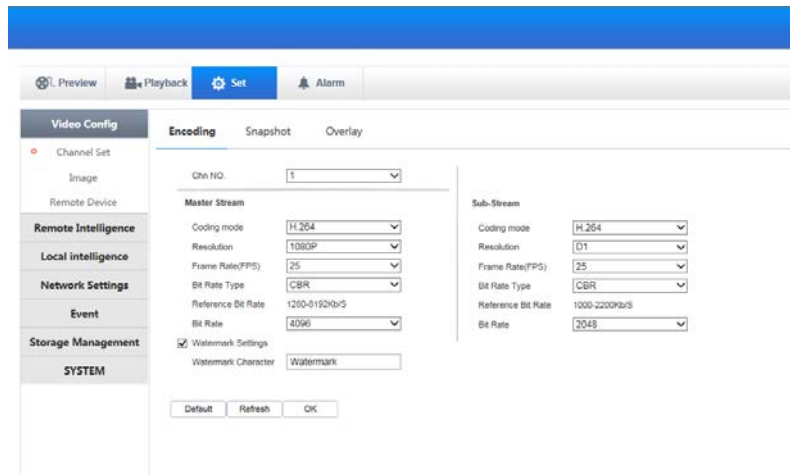

8.1.7 Search Record

Click “Search record” to open the search interface (Error! Reference source was not found.), can search and operate record, alarm, motion, local record

Search record

By selecting the record type, start and end times, and click the check button, get a list of files on the DVR. Select the appropriate file and download can be played

Play

Double click a search result to play in video window. Control the playing video by the control keys on the bottom. At this point, the bottom of the video window will display the video control buttons, video playback can be controlled.



Download: select a searched video to download to local. The download speed and percentage are displayed on the bottom of the screen.

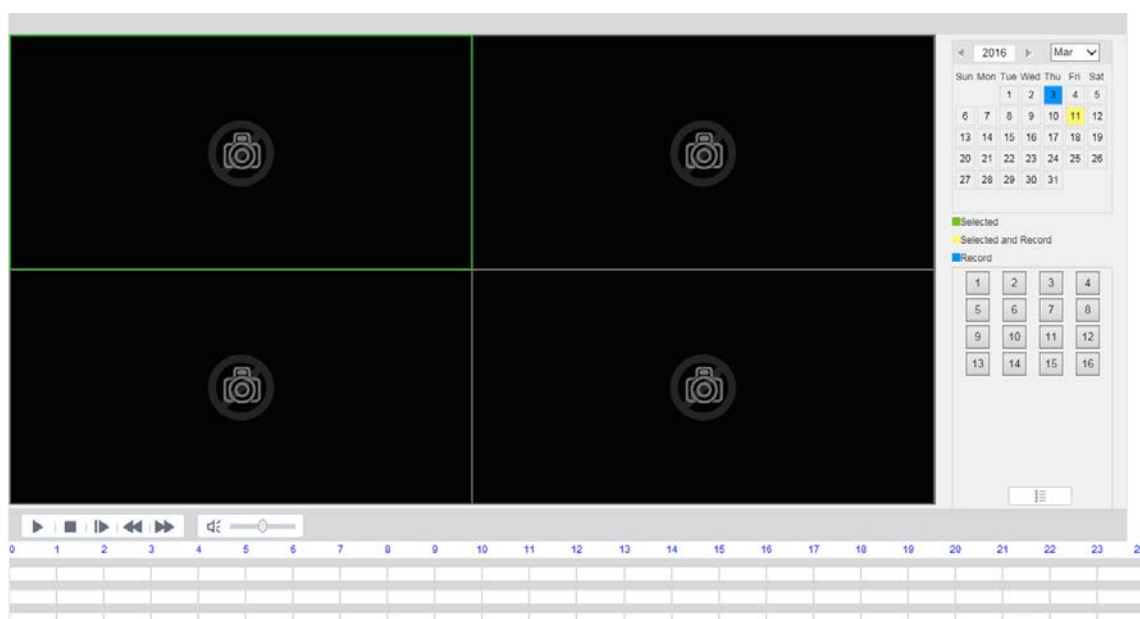

8.1.8 Alarm Configuration

Click the [**Alarm**] to enter the alarm setup menu, users can set up and operate the alarm mode, as show 5-11.

If need warning message displayed and real-time pop up on the WEB interface , open the [**monitor alarm**], and select the appropriate type of alarm.

Choose type of alarm on menu, monitor video loss, motion detection, disk full, disk error, video mask, external alarm.

Click [**Video Pop-up**], open the video loss, motion detection, hard disk full, hard disk failure, video block, video encoder alarm pop-up linkage.

Click [**prompt**]open the prompt: When an alarm occurs in real-time monitoring will popup alarm window menu.

Click [**Sound Pop-up**], you can choose alarm tone pre-recorded on the local hard drive when an alarm occurs, tone file in WAV format.

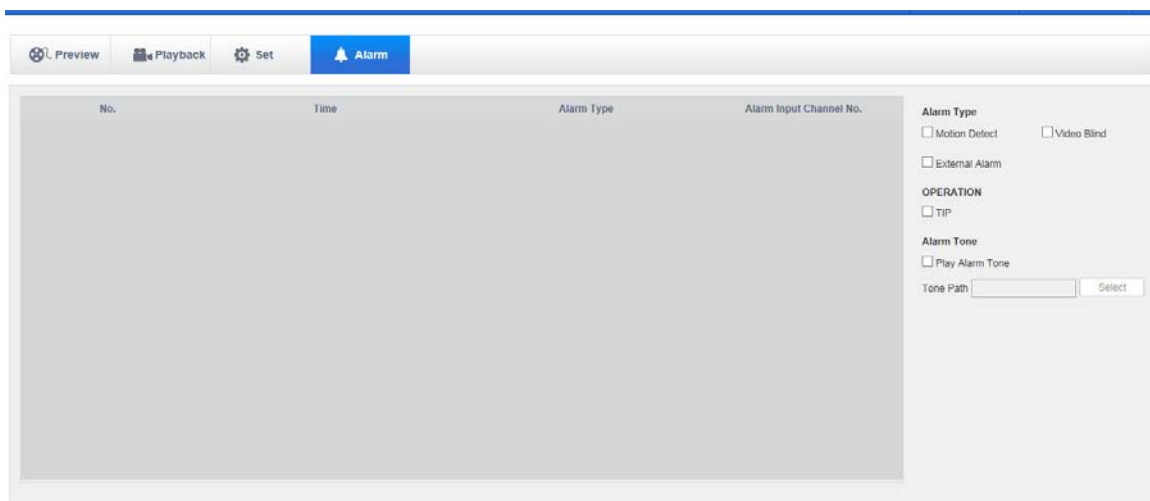

8.1.9 About

WEB Controls version information show here.

9 Appendix

9.1 Alarm linkage setting

Alarm linkage settings interface as following.

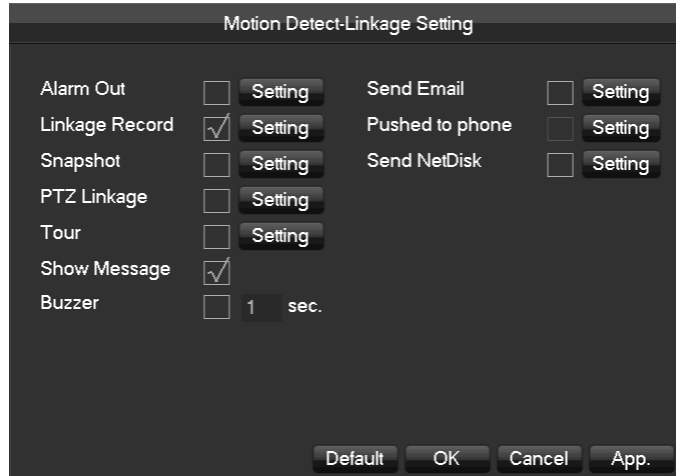

9.1.1 Alarm Out

Linkage the device alarm through the interface as following:



Support 10s-300s alarm-delay.

9.1.2 Linkage Record

Video channel linkage.

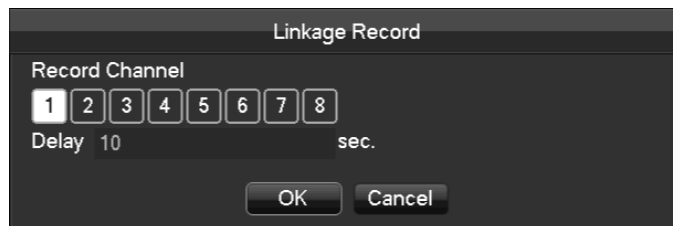

Support 10s-300s alarm-delay.

9.1.3 Snapshot

Screenshots through channel linkage as the interface following:

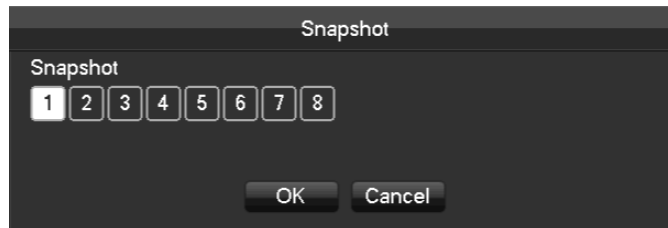

Configure the screenshots by setting **[main menu]-[screenshot setting]**.



Attention:if the access channel is the network channel , please check if the screenshot function is open of the camera.

9.1.4 PTZ Linkage

Preset position, cruise,trace by setting the PTZ linkage.

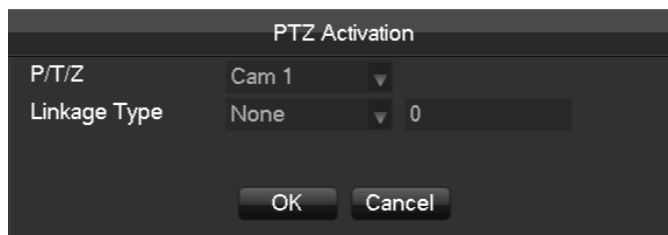

Preset position, cruise,trace by setting the PTZ configuration. See details on page 66.2.

9.1.5 Tour

Select the round tour channel, when the alarm occurs, select the single channel to the round tour.

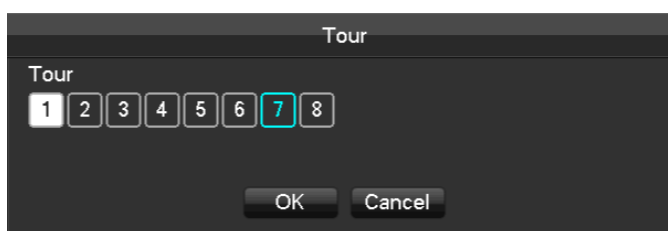

9.1.6 Show Message

Select the prompt to open the screen, if it occurs alarm, the preview screen will pop up the prompt as following:

The image shows a configuration window titled "Alarm Status". It contains several rows of status indicators:

- Alarm In:** A row of 16 numbered buttons (1-16).
- Video Lost:** A row of 8 numbered buttons (1-8).
- Mask:** A row of 8 numbered buttons (1-8).
- Motion:** A row of 8 numbered buttons (1-8).
- Network:** Two empty square checkboxes.
- IP Conflict:** Two empty square checkboxes.

9.1.7 Buzzer

Select the buzzer, the buzzer can last 1s-600s.

9.1.8 Send Email

Email configuration interface is as following:

The image shows an "EMAIL" configuration window with the following fields and options:

- SMTP Server:** MailServer
- Port:** 25
- User Name:** (empty text field)
- Password:** (empty text field)
- From:** (empty text field)
- Title:** DVR ALERT
- Receiver:** (empty text field)
- Receiver:** (empty text field)
- Receiver:** (empty text field)
- Event Interval:** 0
- sec. SSL Enable:**
- Enable:**

At the bottom of the window are four buttons: OK, Cancel, App., and Test.

Configure the SMTP server, IP address, ports, user name, password and the email address of the sender, SSL encrypt the email. The title of the email can support English and the Arab number, the maximum input characters reach as much as 32 characters.

9.1.9 Server push

Server push configuration interface as following:

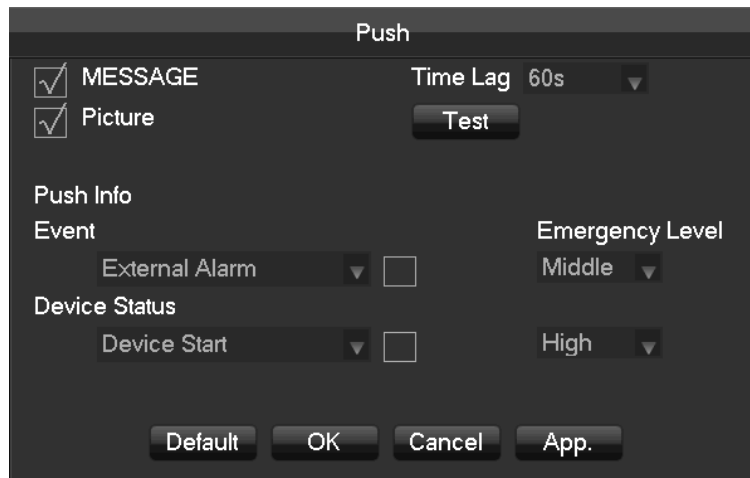

[send message]open or close the mobile phone message sending

[image attachment]Open the function of image attachment.

[Time Lag]set the time lag of the message sending, 60s/90s/120s is optional.

[Test]Click Send to test the message sending function

[Event]Open or close the event sending, the events including external alarm, face detection, perimeter intrusion detection.

[Device exception]Open and close the device exceptional sending, the exception including the device startup, no hard dick, error hard dick, start recording/stop recording.

[Urgency Degree] the message sending level can be divided into High/Medium/Low level.

9.1.10 Send NetDisk

Choose baidu cloud disk, Dropbox, Google one, according to clew for binding.

Support motion detection, video occlusions, local alarm (face/perimeter) alarm and other alarm types.

Can linkage other channels to upload the captured pictures

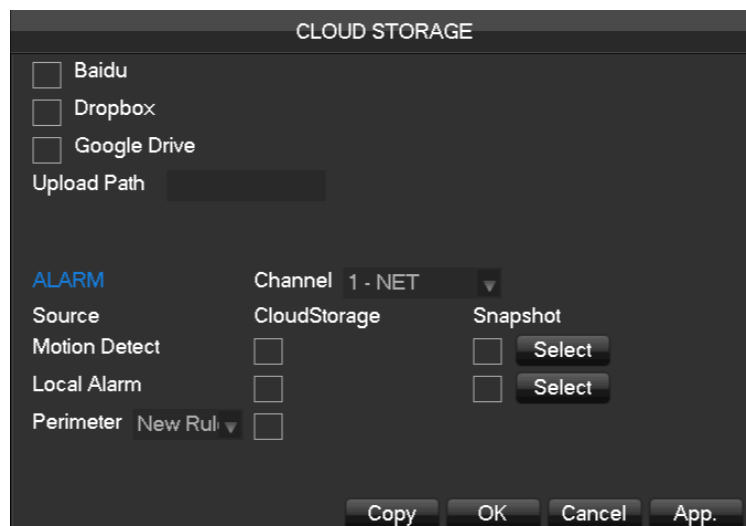

9.2 Port Mapping

Port mapping is mapping a port of outside web host's IP address to a machine inside web, and provide the service. When user connects to the port of the IP, the server will automatically map the request to the corresponding machine inside LAN. With this function, we can map many ports of a machine's IP address to different machines' different ports inside web. The port mapping can also have other special agent functions, like POP, SMTP, Telnet and so on. Theoretically, it can provide more than sixty thousand ports. For example, if we want to map a web server which has an IP address of 192.168.111.10, we just need to input the IP address and TCP port 80 into the port mapping chart of the router. There are two ways to map the port: UPnP function automatically map and modify the router's port mapping chart by manual.

9.2.1 UPNP Function

In order to get connection to the Embedded DVR through Public network, we need to set the Router to cross the NAT of Embedded DVR. UPnP can make the NAT cross automatically by the UPnP agreement of Embedded DVR, and don't have to set the Router.



Note: to realize the UPnP Function, there must be Router support and enable the UPnP Function.

The first step

Connect the Router to the network, get to the Menu of the Router, set the Router, and enable the UPnP Function. Routers made by different manufacturers may have some difference, please refer to the specification carefully before setting the Router.

The second step

Connect the Embedded DVR to the Router; the configuration will automatically gain the IP address or static IP. After setting up the IP, click the Advanced. And get to the XXX, ports and multicast etc. choose to open the Enable at the [UPnP port mapping]

The third step

Enter into the Router management interface; detect the port if there is already a Port mapping. If there is, it shows UPnP setting's finished.

The forth step

Input the IP address in IE, and add port number of the Embedded DVR, for example: 155.157.12.227:81. If you want to enter by the Client Software, use the TCP port offered by the outer net.



Note: if there are a few embedded DVRs need to set the UPnP function, in order to avoid IP conflict, set the ports of embedded DVR into different ports numbers. Otherwise, it will choose the embedded DVR port set preceded as the first choice.

9.2.2 Port mapping Manually

The first step

Connect the Embedded DVR to the Router, set the static IP.

The second step

Log in Router, enter into the configuration menu of Router, and set the menu. Then get to port, set the IP distributed by the Embedded DVR, and set the rule of port mapping, add HTTP and TCP port into mapping list.

Default access ports of Embedded DVR include HTTP port 80 and TCP port 8000, if the ports are occupied by the other devices, please modify the default port of the Embedded DVR into other vacant ports.

The third step

Input the public net IP address in the IE, and add the port number of the Embedded DVR you want to access after the IP, for example: http://155.157.12.227:81. If you want to access by Client Software, you can use the outer net TCP port directly.



Notice: for detail configuration setting, please refer to the user manual of Router.

9.3 Voice Intercom

9.3.1 Summarize

Embedded DVR Bidirectional Talk: user can talk to remote client software or Web via DVR audio input and output ports; user can listen voice from Client Software and WEB via DVR audio output ports.

Two types of bidirectional talk ---- sharing and standalone ----for different models, exact info please refer to specifications.

o

9.3.2 Configuration

Local configuration

Connect a microphone to the MIC input port, connect loudspeaker to the audio output port.

If no standalone MIC input port, please connect microphone to the number 1 audio input port



Note: local output needs active audio output device.

Remote PC Configuration

Connect microphone and loudspeaker to computer.

Enable bidirectional talk in IMS software or WEB.

9.4 HDD S.M.A.R.T

S.M.A.R.T: “Self-Monitoring, Analysis and Reporting Technology”

S.M.A.R.T HDD can analysis head, disc, motor, circuit operation, history and default security values via monitor instruction in HDD and surveillance software in host. Alarm will be sent to user automatically when the value is outside the scope of the security situation.

Detection parameters of Seagate HDD for example are divided into seven: ID detection code, Attribute Description, Threshold, Attribute Value, Worst, Date, and Status.

1、 ID detection code

ID detection code is not the only; manufacturer can use different ID code or increase or decrease its quantity according to the detected parameter's quantity.

For example: the ID detection code of WEASTERN DIGITAL's product is "04", parameter is Start/Stop Count, but the parameter of same code in Fujitsu's product is "Number of times the spindle motor is activated".

2、 Attribute Description

Attribute Description: name of detection item. Manufacturer can increase or decrease. As ATA standard update constantly, sometimes different models in same brand maybe different ,but must ensure major test items specified in S.M.A.R.T .(although different manufacturers have specific naming convention ,the essence of monitoring is the same.)

- 1 Read Error Rate
- 2 Spin up Time
- 4 Start/Stop Count
- 5 Relocated Sector Count
- 7 Seek Error Rate
- 9 Power-on Hours Count
- 10 Spin up Retry Count
- 194 Power temperatures
- 195 ECC on the Fly count
- 197 Current Pending Sector Count
- 198 Disconnection beyond repair
- 199 CRC cyclic redundancy check
- 200 Write Error Count



Note: Different manufacturers and different models have different attribute description , the user has no need to know exact meaning ,attribute detection values enough for them.

3、 Threshold

It is specified by manufacturer calculated through a specific formula. If there is a attribute value lower than the threshold, which means HDD become unreliable and data stored is very easy to lose. Composition and size of reliable attribute values is different for different HDD. It should be noted that, ATA standard only provides some SMART parameters; it does not provide a specific value. "Threshold" value is determined by manufacturers based on products' features. Thus, results tested by manufacturer provided detection software is very different from testing software under Windows (such as AIDA32)

4、 Attribute Value

Attribute value is the maximum normal value; the general range is from 1 to 253. Typically, the maximum attribute value is 100 (for IBM, Quantum, and Fujitsu) or 253 (for Samsung). Of course, there are some exceptions, for example, some models produced by Western Digital have two different attribute values, and property value is set 200 when initial production, but after then it is changed into 100.

5、 Worst

Worst value is the largest non-normal value in HDD's running. It is a value calculate for HDD's cumulative running, it is constantly refreshed according to running cycle, and very closed to the threshold. Whether the HDD is normal by S.M.A.R.T analysis is based on the comparison with threshold. The maximum value appear when new HDD start to use, which would continue to decrease with the everyday use or error happen. Consequently, larger attribute values mean better quality and higher reliability; smaller values mean more possibility of failure

increases.

6、Dates

Actual values of HDD's detection items, many items are cumulative values.

7、Status

It is current statuses of HDD's every attribute after analyzing and comparing above attribute values by S.M.A.R.T, also is important information to judge HDD healthy or not.

There are three statuses: Normal, Alarm and Error----which is closely related with Pre-failure/advisory BIT.

9.5 Hard disk problem

Use Detection Tool provided by the HDD manufacturer to detect the Function of HDD to solve data problem.

We recommend Seagate and Western Digital.

How to detect Seagate HDD

- a) Get into www.seagate.com, Click Support & Downloads →choose Sea Tools, download tool, as Diagram

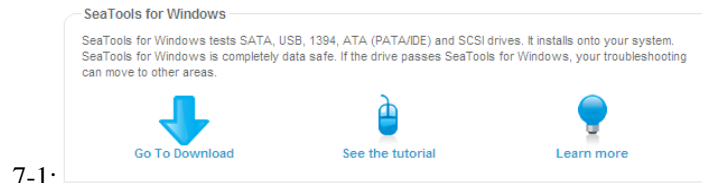

Diagram 9-1 Seagate download

- b) Double-click to install downloaded file, click installed file to detect the HDD information on PC.
c) Choose the HDD for detection (other manufacturer's hard disk suitable too).

How to detect WDC HDD

- a) Get into www.wdc.com, choose WD support / download / SATA&SAS / WD Caviar / GP, download software as Diagram 9-2 WD Download



Diagram 9-2 WD Download

- b) Click Icon to hard disk detection after downloading.
c) Double click hard desk in device list, as Diagram 9-3 WD Detection:

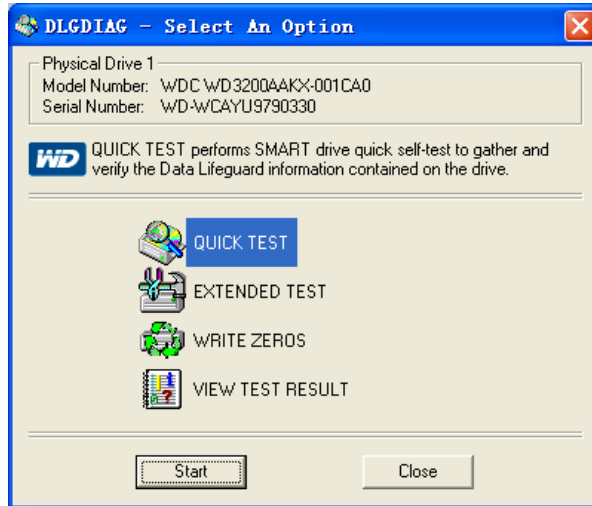

Diagram 9-3 WD Detection

9.6 HDD Capacity Calculation

Reference of HDD Capacity Calculation

The first time install DVR, please check if the HDD has installed.

The capacity of the HDD

There is no limitation of capacity of single HDD to DVR, please choose the HDD according to the saving time.

The choose of the Capacity

Computational formula of HDD Capacity:

Whole HDD Capacity = number of the channels × time in need (hour) × spent of HDD Capacity per hour (MB/hour)

Similarly we can have the formula of recording time:

$$\text{Recordingtime (hour)} = \frac{\text{TotalHDDCapacity (MB)}}{\text{CapacityOccupationperHour (MB/hr)} \times \text{AmountofChannel}}$$



Note: 1GB=1000MB, not 1GiB=1024MiB, so HDD capacity shown in Base Configuration under HDD Management less than real marked.

File size per hour (CBR).

Form 9-1 record file size

Bit Rate	File	Bit Rate	File	Bit Rate	File
96k	42M	320k	140M	896k	393M
128k	56M	384k	168M	1.00M	450M
160k	70M	448k	196M	1.25M	562M
192k	84M	512k	225M	1.50M	675M
224k	98M	640k	281M	1.75M	787M
256k	112M	768k	337M	2.00M	900M

File size is more unpredictable when VBR style, please refer to the real size of recording file.

9.7 Terms

Dual-stream

Dual-stream: one high bit rate stream for the local HD store, QCIF/CIF/2CIF/DCIF/4CIF coding, other low bit rate stream for network transmission, such as QCIF / CIF coding,

I Frame

I frame: intra frame image, remove redundant information to compress the transmittal data, also called key frames.

B Frame

B frame: According to time redundant of the source image sequence previously encoded frame and account the source image after the encoded frame to compress transmittal data, also known as bi-directional prediction frame.

P Frame

P-frame: according to image frame lower than the previous 'time redundant to compress transmittal data, also called predicted frames.

Wide Dynamic

Bright parts and dark parts in particular can be seen very clearly at the same time. Wide dynamic range is a ratio between the brightest luminance signal value and the darkest value.

S. M. A. R. T

SMART (Self Monitoring, Analysis and Reporting Technology): now widely used in hard disk data security technology, monitoring system analysis Motor, circuit, HDD and disk head when HDD working, warn when abnormality, sometimes will automatically slow down and back up data.

CVBS

Composite Video Broadcast Signal, consists of luminance and color signal from the composite baseband signal.

BNC

Coaxial cable connector, composite video signals or audio signals, commonly use 75 ohm connectors. BNC welding and should pay attention to weld strength and remove burrs, or the signal wire and shield's contact will lead to a substantial attenuation of signal strength

9.8 FAQ

DVR startup failure or continuously reboot

Possible reasons:

1. The system has been damaged from a bad DVR update.
2. There is a problem with the DVR main board error, please contact supplier.
3. There is an HDD error. Replace faulty HDD.

Remote control does not work

Possible reasons:

1. Check for batteries in remote control, especially positive and Negative.
2. Check for batteries' power.
3. Check if remote receiver is obscured.
- 3 Check if DVR address corresponds to the remote address.

DVR cannot control PTZ

Possible reasons:

1. RS-485 cable connection error, A, B ports are inversely connected;
2. PTZ decoder, protocol, baud rate, address are incorrect;
3. Parallel connect a 120Ω resistance to resolve signal reflex caused by too many PTZs on the line.
4. The RS-485 on the DVR is defective

Blurred screen in preview mode

Possible reasons:

Please make sure your cameras match your video format selected in the General menu. E.g. camera is NTSC standard but the DVR is PAL standard, the preview would be blurred.

Blurred screen in playback mode or failure to playback records

Possible reasons:

1. Procedure error, reboot the DVR
2. HDD error, test or change out the HDD
3. DVR hardware failure, contact your local supplier

Fail to connect DVR through network

Possible reasons:

1. check the physical network connection is correct.
2. check the DVR network configuration parameters.
3. check whether IP conflicts exist in network.

Download records can't be played

Possible reasons:

1. Player installation error.
2. The USB or HDD device has an error.
3. Do not install graphic software later than DX8.1.

Internet Explore Crash

Possible reasons:

Close IE explore, enter into the tool bar

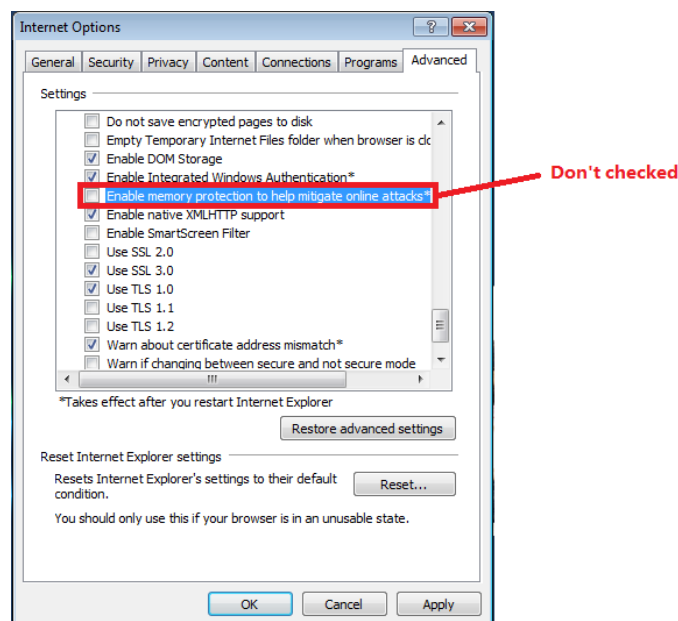

Diagram 9-4 IE tool bar